

ICOM INSTRUCTIONS

VHF P25 TRUNKING HANDHELD TRANSCEIVERS IC-F9011 series UHF P25 TRUNKING HANDHELD TRANSCEIVERS IC-F9021 series IC-F9023 series

Thank you for choosing this Icom product.
READ ALL INSTRUCTIONS carefully and completely before using this product.

SAVE THIS INSTRUCTIONS — This instruction sheet contains important operating instructions for the IC-F9011B/IC-F9011S/IC-F9011T VHF P25 TRUNKING HANDHELD TRANSCEIVERS and the IC-F9021B/IC-F9021S/IC-F9021T, IC-F9023B/IC-F9023S/IC-F9023T UHF P25 TRUNKING HANDHELD TRANSCEIVERS.

When the optional UT-125 AES/DES ENCRYPTION UNIT is installed:

When you attempt to re-export this product and/or AES encryption of this product is activated, you must comply with the export regulations of your country, which can be highly restrictive. **YOUR FAILURE TO COMPLY WITH EXPORT REGULATIONS MAY SUBJECT YOU TO FINES OR PENALTIES.** AES encryption products including this software fall under the control of the Japanese Government as described in Appendix I: Export Legal Controls and Appendix: Exchange Legal Controls. Please consult with your dealer or sales representative for details.

Icom is not responsible for the destruction, damage to, or performance of any Icom or non-Icom equipment, if the malfunction is because of:

- Force majeure, including, but not limited to, fires, earthquakes, storms, floods, lightning, other natural disasters, disturbances, riots, war, or radioactive contamination.
- The use of Icom transceivers with any equipment that is not manufactured or approved by Icom.

Icom, Icom Inc. and the Icom logo are registered trademarks of Icom Incorporated (Japan) in Japan, the United States, the United Kingdom, Germany, France, Spain, Russia, Australia, New Zealand, and/or other countries. AMBE+2 is a trademark and property of Digital Voice Systems Inc. All other products or brands are registered trademarks or trademarks of their respective holders.

Icom Inc. **Count on us!**
1-1-32 Kamiminami, Hirano-ku, A6662D-1US-9
Osaka 547-0003, Japan Printed in Japan
Jul. 2019 © 2008–2019 Icom Inc.

SAFETY TRAINING INFORMATION



Your Icom radio generates RF electromagnetic energy while transmitting. This radio is designed for and classified as for "Occupational Use Only." This means it must be used only during the course of employment by individuals aware of the hazards, and the ways to minimize such hazards. This radio is NOT intended for use by the "General Population" in an uncontrolled environment. This radio has been tested and complies with the FCC and IC RF exposure limits for "Occupational Use Only". In addition, your Icom radio complies with the following Standards and Guidelines with regard to RF energy and electromagnetic energy levels and evaluation of such levels for exposure to humans:

- FCC KDB Publication 447498 D03, Evaluating Compliance with FCC Guidelines for Human Exposure to Radio Frequency Electromagnetic Fields.
- American National Standards Institute (C95.1-1992), IEEE Standard for Safety Levels with Respect to Human Exposure to Radio Frequency Electromagnetic Fields, 3 kHz to 300 GHz.
- American National Standards Institute (C95.3-1992), IEEE Recommended Practice for the Measurement of Potentially Hazardous Electromagnetic Fields—RF and Microwave.
- The antennas, batteries, belt clips, speaker-microphone, and other accessories that are listed in "OPTIONS" on this sheet, are authorized for use with this product. Use of accessories other than those specified may result in RF exposure levels exceeding the FCC and IC requirements for wireless RF exposure.
- Health Canada Safety Code 6 - Limits of Human Exposure to Electromagnetic Energy in the Frequency Range from 3 kHz to 300 GHz.



To ensure that your exposure to RF electromagnetic energy is within the FCC and IC allowable limits for occupational use, always adhere to the following guidelines:

- **DO NOT** operate the radio without a proper antenna attached, as this may damage the radio and may also cause you to exceed FCC and IC RF exposure limits. A proper antenna is the antenna supplied with this radio by the manufacturer or an antenna specifically authorized by the manufacturer for use with this radio.
- **DO NOT** transmit for more than 50% of the total radio use time ("50% duty cycle"). Transmitting more than 50% of the time can cause FCC and IC RF exposure compliance requirements to be exceeded. The radio is transmitting when the status indicator lights red. You can cause the radio to transmit by pushing the "PTT" switch.
- **ALWAYS keep** the antenna at least 2.5 cm (1 inch) away from the body when transmitting, and only use the Icom belt-clips listed in "OPTIONS" on this sheet when attaching the radio to your belt, or other place, to ensure FCC and IC RF exposure compliance requirements are not exceeded. The information listed above provides the user with the information needed to make him or her aware of RF exposure, and what to do to assure that this radio operates within the FCC and IC RF exposure limits of this radio.

RECOMMENDATION

CLEAN THE TRANSCEIVER THOROUGHLY IN A BOWL OF FRESH WATER after exposure to saltwater, and dry it before operating. Otherwise, the transceiver's keys, switches, and controllers may become unusable, due to salt crystallization, and/or the charging terminals of the battery pack may corrode.

NOTE: If the transceiver's waterproof protection appears defective, carefully clean the transceiver with a soft, damp (fresh water) cloth, then dry it before operating. The transceiver may lose its waterproof protection if the case, jack cap, or connector cover is cracked or broken, or the transceiver has been dropped. Contact your Icom distributor or your dealer for advice.

EXPLICIT DEFINITIONS

WORD	DEFINITION
⚠ DANGER!	Personal death, serious injury or an explosion may occur.
⚠ WARNING!	Personal injury, fire hazard or electric shock may occur.
CAUTION	Equipment damage may occur.
NOTE	If disregarded, inconvenience only. No risk of personal injury, fire or electric shock.

PRECAUTIONS

⚠ **DANGER!** Use and charge only specified Icom battery packs with Icom radios or Icom chargers. Only Icom battery packs are tested and approved for use with Icom radios or charged with Icom chargers. Using third-party or counterfeit battery packs or chargers may cause smoke, fire, or cause the battery to burst.

⚠ **WARNING! NEVER** hold the radio so that the antenna is very close to, or touching exposed parts of the body, especially the face or eyes, while transmitting. The radio will perform best if the microphone is 5 to 10 cm (2 to 4 inches) away from the lips and the radio is vertical.

⚠ **WARNING! NEVER** operate the radio with a headset or other audio accessories at high volume levels. The continuous high volume operation may cause a ringing in your ears. If you experience the ringing, reduce the volume level or discontinue use.

⚠ **WARNING! NEVER** operate the radio while driving a vehicle. Safe driving requires your full attention—anything less may result in an accident.

CAUTION: MAKE SURE the flexible antenna and battery pack are securely attached to the radio, and that the antenna and battery pack are dry before attachment. Exposing the inside of the radio to water will result in serious damage to the radio.

DO NOT push [PTT] when you do not actually intend to transmit.

DO NOT operate or place the radio in direct sunlight or in areas with temperatures below -20°C (-4°F) or above $+60^{\circ}\text{C}$ ($+140^{\circ}\text{F}$).

DO NOT modify the radio. The specifications may change and then not comply with the requirements of a corresponding regulation. The radio warranty does not cover any problems caused by unauthorized modification.

DO NOT operate the radio near unshielded electrical blasting caps.

DO NOT use harsh solvents such as benzene or alcohol when cleaning, as they will damage the radio surfaces.

BE CAREFUL! The transceiver meets IP67 requirements for dust-protection and waterproof protection. However, once the transceiver has been dropped, dust-protection and waterproof protection cannot be guaranteed due to the fact that the transceiver may be cracked, or the waterproof seal damaged, etc.

BE CAREFUL! The radio will become hot when operating it continuously for long periods of time.

MAKE SURE to turn OFF the radio power before connecting or disconnecting the supplied/optional accessory.

Even when the radio power is OFF, a slight current still flows in the circuits. Remove the battery pack or batteries from the radio when not using it for a long time. Otherwise, the installed battery pack or batteries will become exhausted, and will need to be recharged or replaced.

⚡ Battery caution

- Misuse of Li-ion batteries may result in the following hazards: smoke, fire, or the battery pack may rupture. Misuse can also cause damage to the battery pack or degradation of battery performance.
- Prior to using the battery pack for the first time, or after not using it for a long time, you must fully charge the pack. Otherwise, the transceiver may not turn ON.

⚠ **DANGER! NEVER** short terminals (or charging terminals) of the battery pack. Also, current may flow into nearby metal objects such as a key, so be careful when placing the battery packs (or the radio) in handbags, etc. Simply carrying with or placing near metal objects such as a key, etc. may cause shorting. This may damage not only the battery pack, but also the radio.

⚠ **DANGER! DO NOT** hammer or otherwise impact the battery pack. Do not use the battery pack if it has been severely impacted or dropped, or if it has been subjected to heavy pressure. The damage may not be visible on the outside of the case. Even if the surface of the battery pack does not show cracks or any other damage, the cells inside may rupture or catch fire.

⚠ **DANGER! NEVER** use or leave the battery pack in areas with temperatures above $+60^{\circ}\text{C}$ ($+140^{\circ}\text{F}$). High temperature buildup in the battery pack, such as could occur near fires or stoves, inside a sun heated car, or in direct sunlight for long periods of time may cause the battery pack to rupture or catch fire. Excessive temperatures may also degrade performance or shorten battery life.

⚠ **DANGER! DO NOT** expose the battery pack to rain, snow, seawater, or any other liquids. Do not charge or use a wet battery pack. If the battery pack gets wet, be sure to wipe it dry before using.

⚠ **DANGER! KEEP** the battery pack away from fire. Fire or heat may cause them to rupture or explode. Dispose of an used battery pack in accordance with local regulations.

⚠ **DANGER! NEVER** solder the battery pack terminals, or modify the battery pack. This may generate heat in the battery, and the battery pack may burst, emit smoke or catch fire.

⚠ **DANGER!** Use the battery pack only with the radio for which it is specified. Never use a battery pack with any other equipment, or for any purpose that is not specified in this sheet.

⚠ **DANGER!** If fluid from inside the battery pack gets in your eyes, blindness can result. Rinse your eyes with clean water, without rubbing them, and see a doctor immediately.

⚠ **WARNING!** Immediately stop using the battery pack if it emits an abnormal odor, heats up, or is discolored or deformed. If any of these conditions occur, contact your Icom dealer or distributor.

SUPPLIED ACCESSORIES

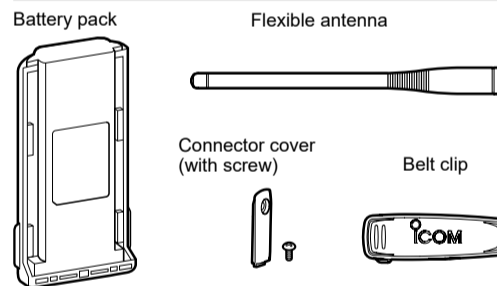

NOTE: Some accessories are not supplied, or the shape is different, depending on the transceiver version.

⚡ Battery pack

To attach the battery pack:
Slide the battery pack on the back of the transceiver in the direction of the arrow (1), then lock it with the battery release button.

To release the battery pack:
Slide the battery release button in the direction of the arrow (2) as shown below. The battery pack is then released.

NEVER release or attach the battery pack when the transceiver is wet or soiled. This may result water or dust getting into the transceiver/battery pack and may result in the transceiver being damaged.

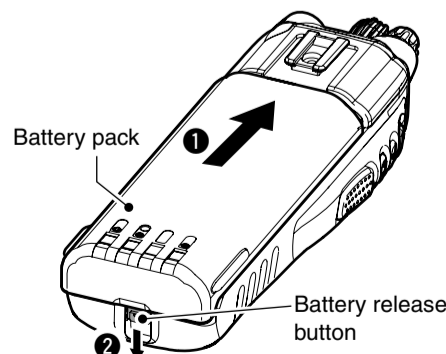

NOTE: Keep battery terminals clean. It's a good idea to occasionally clean them.

⚠ **WARNING!** Immediately wash, using clean water, any part of the body that comes into contact with fluid from inside the battery pack.

⚠ **WARNING! NEVER** use deteriorated battery packs. They could cause a fire.

⚠ **WARNING! NEVER** put the battery pack in a microwave oven, high-pressure container, or in an induction heating cooker. This could cause a fire, overheating, or cause the battery pack to rupture.

CAUTION: Always use the battery pack within the specified temperature range: -30°C to $+60^{\circ}\text{C}$ (-22°F to $+140^{\circ}\text{F}$) and the battery itself (-20°C to $+60^{\circ}\text{C}$; -4°F to $+140^{\circ}\text{F}$). Using the battery pack out of its specified temperature range will reduce the performance and the life.

CAUTION: Shorter battery life could occur if the battery pack is left fully charged, completely discharged, or in an excessive temperature environment (above $+45^{\circ}\text{C}$; $+113^{\circ}\text{F}$) for an extended period of time. If the battery pack must be left unused for a long time, it must be detached from the radio after discharging. You may use the battery pack until the remaining capacity is about half, then keep it safely in a cool and dry place at the following temperature range: -20°C to $+45^{\circ}\text{C}$ (-4°F to $+113^{\circ}\text{F}$) (within a month) -20°C to $+35^{\circ}\text{C}$ (-4°F to $+95^{\circ}\text{F}$) (within three months) -20°C to $+25^{\circ}\text{C}$ (-4°F to $+77^{\circ}\text{F}$) (within a year)

BE SURE to replace the battery pack with a new one approximately five years after manufacturing, even if it still holds a charge. The inside battery material will become weak after a period of time, even with little use. The estimated number of times you can charge the battery is between 300 and 500.

Even when the battery appears to be fully charged, the operating time of the transceiver may become short when:

- Approximately five years have passed since the battery was manufactured.
- The battery has been repeatedly charged.

⚡ Charging caution

⚠ **DANGER! NEVER** charge the battery pack in areas with extremely high temperatures, such as near fires or stoves, inside a sun-heated vehicle, or in direct sunlight. In such environments, the safety/protection circuit in the battery pack will activate, causing the battery to stop charging.

⚠ **WARNING! NEVER** charge or leave the battery pack in the battery charger beyond the specified time for charging. If the battery pack is not completely charged by the specified time, stop charging and remove the battery pack from the battery charger. Continuing to charge the battery pack beyond the specified time limit may cause a fire, overheating, or the battery pack may rupture.

⚠ **WARNING!** Occasionally observe the battery pack condition while charging. If any abnormal condition occurs, discontinue using the battery pack.

⚠ **WARNING! NEVER** insert the radio (the battery pack attached to the radio) into the charger if it is wet or soiled. This could corrode the battery charger terminals or damage the charger. The charger is not waterproof.

CAUTION: NEVER charge the battery pack outside of the specified temperature range: 0°C to $+40^{\circ}\text{C}$ ($+32^{\circ}\text{F}$ to $+104^{\circ}\text{F}$). Icom recommends charging the battery at $+20^{\circ}\text{C}$ ($+68^{\circ}\text{F}$). The battery pack may heat up or rupture if charged out of the specified temperature range. Additionally, battery performance or battery life may be reduced.

CAUTION: DO NOT place the charger on unstable surfaces.

⚡ Flexible antenna

Connect the supplied flexible antenna to the antenna connector.

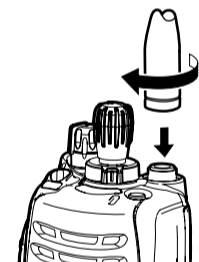

CAUTION:

- **DO NOT** carry the transceiver by holding only the antenna.
- **DO NOT** connect an antenna other than those listed in the "OPTIONS" section.
- Transmitting without an antenna may damage the transceiver.

⚡ Belt clip

To attach the belt clip:

1. Release the battery pack if it is attached.
2. Slide the belt clip in the direction of the arrow until the belt clip is locked and makes a 'click' sound.

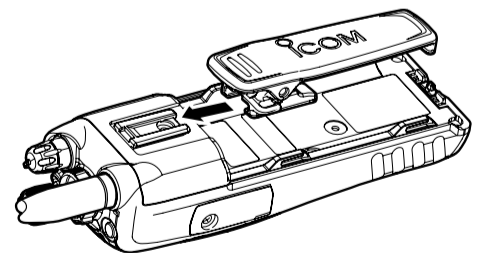

To detach the belt clip:

1. Release the battery pack if it is attached.
2. Pinch the clip (1), and slide the belt clip in the direction of the arrow (2).

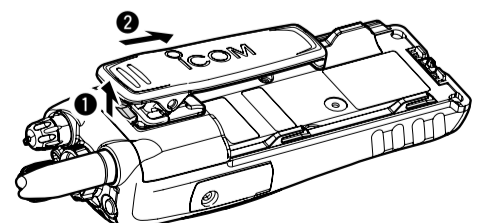

PANEL DESCRIPTION

There are 3 types of transceivers in the IC-F9011, IC-F9021 and IC-F9023 series.

- IC-F9011B/IC-F9021B/IC-F9023B: Non-display type
- IC-F9011S/IC-F9021S/IC-F9023S: Simple type
- IC-F9011T/IC-F9021T/IC-F9023T: 10-key type

The illustration below shows the 10-key type transceiver.

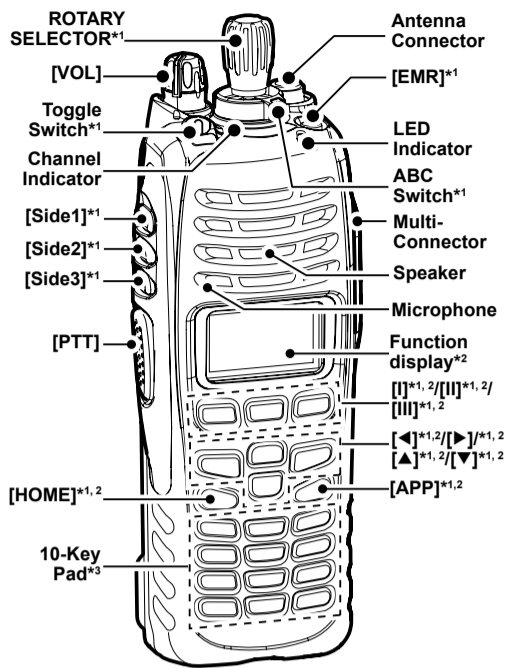

*1: Dealer assignable.
*2: Simple/10-key types only
*3: 10-key type only

LED Indicator

- Lights green while receiving a signal, or when the squelch is open.
- Lights red while transmitting.
- The LED indicator indicates some information. (Non-display type only)

Multi-connector

CAUTION: Attach the connector cover when the optional equipment is not used. Otherwise the terminals of the multi-connector may be shorted by metal object, etc., and this could damage the transceiver.

Toggle Switch

When the toggle switch is set to the left side (◊), the pre-programmed function will be activated.

Chanel Indicator

- Lights white according to the "Backlight" setting of the user set mode.
- When you rotate [Rotary selector] to select the channel or zone, set the desired channel/zone number to this point.

Function display (Simple/10-key types only)

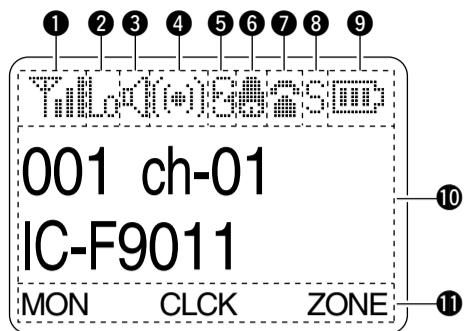

1 SIGNAL STRENGTH INDICATOR

Indicates relative signal strength level.

2 LOW POWER INDICATOR

Appears when low output power is selected.

3 AUDIBLE INDICATOR

Appears when the channel is in the 'audible' (unmute) condition.

4 COMPANDER INDICATOR

Appears when the compander function* is activated.
* Analog mode operation only.

5 SCRAMBLER INDICATOR

Appears when the voice scrambler or encryption function is activated.

6 BELL INDICATOR

Appears/blinks when the matched signal is received, according to the pre-programming.

7 TELEPHONE INDICATOR

Appears when a phone call* is received.
* P25 operation only.

8 SHORT MESSAGE INDICATOR

Appears when an Status message or Short message is received.

9 BATTERY INDICATOR

Appears or blinks when the battery power decreases to a specified level.

Indication				
Battery level	Full	Middle	Charging required	No battery

blinks when the battery is exhausted

10 ALPHANUMERIC DISPLAY

Displays an operating channel number, channel name, Set mode contents, DTMF code, etc.

11 KEY INDICATOR

Indicate the programmed function of the front panel keys ([I], [II] and [III]).

Rapid charging with the BC-119N+AD-110

The optional BC-119N rapidly charges the Li-Ion battery pack. Charging time: Approximately 4 hours for the BP-254. The following items are additionally required.

- AD-110 CHARGER ADAPTER (purchase separately)
- A power adapter (may be supplied with BC-119N depending on version) or the DC power cable (OPC-515L/CP-23L).

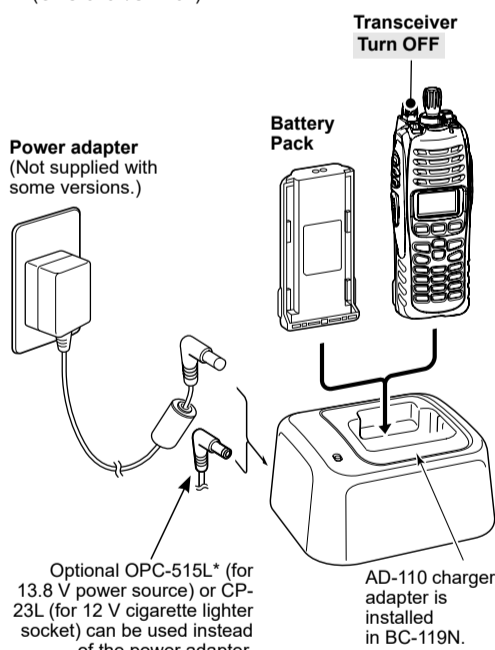

CAUTION: NEVER connect the OPC-515L to a power source using reverse polarity. This will ruin the battery charger.
White line: ⊕ Black line: ⊖

Rapid charging with the BC-121N+AD-110

The optional BC-121N can simultaneously charge up to 6 Li-ion battery packs.

Charging time: Approximately 4 hours for the BP-254. The following items are additionally required.

- Six AD-110 CHARGER ADAPTERS (purchase separately)
- A power adapter (BC-157S) or the DC power cable (OPC-656)

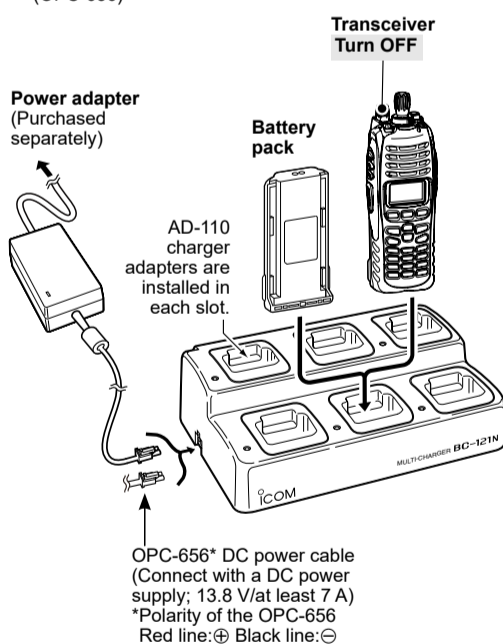

BASIC OPERATION

Turning power ON

NOTE:

- Before using the transceiver for the first time, the battery pack must be fully charged for optimum life and operation. See the BATTERY CHARGING section.
- When you use the transceiver for the first time, or after the transceiver has sat unused for a long time, the date and time indication may be not correct

- Rotate [VOL] to turn ON the transceiver.

Receiving and transmitting

CAUTION: Attach an antenna before transmitting. DO NOT transmit without an antenna.

Receiving:

1. Rotate [VOL] to turn the power ON.
2. Push [CH Up] or [CH Down], or rotate [ROTARY SELECTOR]* to select a channel, in sequence.
* Depending on the presetting.
3. When receiving a call, adjust the audio output level to a comfortable listening level.

Transmitting:

1. Wait for the channel to become clear to avoid interference.
2. While pushing and holding [PTT], speak into the microphone at a normal voice level.
3. Release [PTT] to return to receive.

IMPORTANT:

- To maximize the readability of your signal:
1. After pushing [PTT], pause briefly before you start speaking.
 2. Hold the microphone 5 to 10 cm (2 to 4 inches) from your mouth, then speak at your normal voice level.

BATTERY CHARGING

IMPORTANT: Battery charging caution

Ensure the guide tabs on the battery pack are correctly aligned with the guide rails inside the charger adapter. (This illustration is described with the BC-119N.)

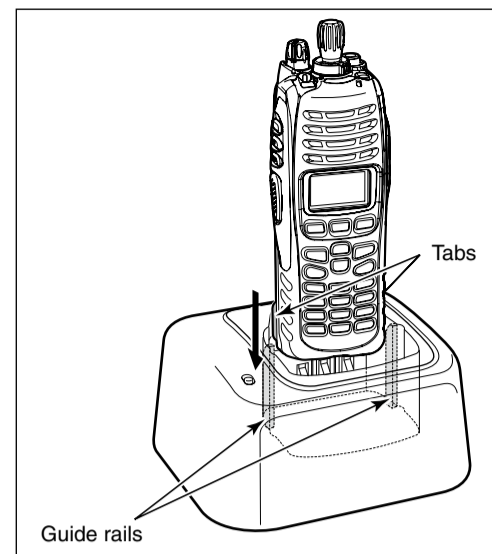

AD-110 installation

The AD-110 CHARGER ADAPTER must be installed into the BC-119N or BC-121N before battery charging.

- Connect the AD-110 and the BC-119N/BC-121N as shown below, then install the AD-110 into the holder space of the BC-119N or BC-121N with the supplied screws.

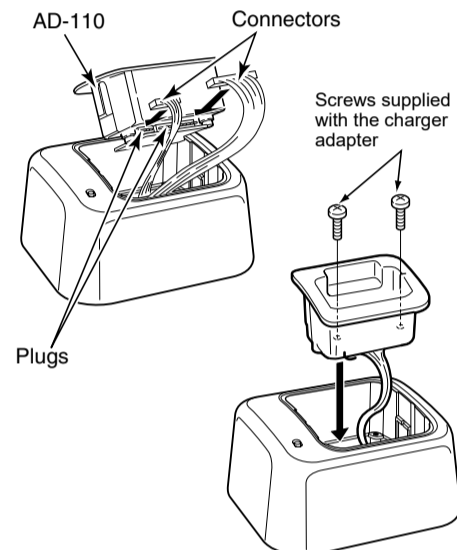

This illustration shows the BC-119N.

OPTIONS

BATTERY PACKS

Battery pack	Voltage	Capacity	Battery life*3
BP-254*1	7.4 V	2900 mAh (min.) 3040 mAh (typ.)	9.5 hrs.
BP-237*2	Battery case for A6 x AA (LR6) alkaline		—*4

1 The BP-254 meets IPX7 requirements for waterproof protection. When it is connected, the transceiver corresponds to IPX7.

2 The BP-237 meets IPX4 requirements for splash resistance. When it is connected, the transceiver corresponds to IPX4.

*3 When the power save function is turned ON, and the operating periods are calculated under the following conditions;
TX : RX : standby = 5 : 5 : 90

*4 Operating period depends on the alkaline cells used.

CHARGERS

- BC-119N DESKTOP CHARGER + AD-110 CHARGER ADAPTER + BC-145S AC ADAPTER
For rapid charging of battery pack. A power adapter is supplied with the charger depending on versions. Charging time: Approximately 4 hours for the BP-254.

- BC-121N MULTI-CHARGER + AD-110 CHARGER ADAPTER (6 pcs.) + BC-157S AC ADAPTER
For rapid charging of up to 6 battery packs (six AD-110s are required) simultaneously. A power adapter should be purchased separately. Charging time: Approximately 4 hours for the BP-254.

CABLES

- CP-23L CIGARETTE LIGHTER CABLE
Allows charging of the battery pack through a 12 V cigarette lighter socket. (For BC-119N)
- OPC-515L/OPC-656 DC POWER CABLES
Allows charging of the battery pack using a 13.8 V power source instead of the power adapter.
OPC-515L : For BC-119N
OPC-656 : For BC-121N
- OPC-1870/OPC-1871 ZONE COPY CABLES
OPC-1870 : Portable to portable zone copy cable.
OPC-1871 : Portable to mobile zone copy cable.

OPTIONAL UNITS

- UT-124R MAN DOWN UNIT
Provides a measure of safety when working in a hazardous environment, etc.
- UT-125 AES/DES ENCRYPTION UNIT
- UT-128 DES ENCRYPTION UNIT

ANTENNAS

- FA-S25V/FA-S65V/FA-S66V/FA-S30U/FA-S58U/
FA-S75U FLEXIBLE ANTENNAS
FA-S25V: 136-148 MHz FA-S30U: 380-430 MHz
FA-S65V: 148-160 MHz FA-S58U: 430-470 MHz
FA-S66V: 160-174 MHz FA-S75U: 470-520 MHz
- FA-S67VC/FA-S76UC CUT ANTENNA
FA-S67VC: 136-174 MHz FA-S76UC: 380-520 MHz

OTHER OPTIONS

- MB-115 BELT CLIP
Exclusive alligator-type belt clip.
- AD-118 ACC ADAPTER
Allows you to connect an accessory which uses a HIROSE plug. See the instruction sheet of the AD-118 for details of the recommended accessories.

CAUTION: The AD-118 does not have any waterproof protection. When it is connected, NEVER expose the adapter and the transceiver to rain, snow or any liquids.

- HM-184/HM-184H SPEAKER-MICROPHONES
Rugged type speaker-microphone.
The HM-184/H meet IP67* requirements for waterproof protection.
- VS-1MC VOX/PTT CASE + HS-94/HS-95/HS-97 HEADSET
VS-1MC:VOX/PTT switch box for hands-free operation, etc.
HS-94: Ear-hook type HS-95: Neck-arm type
HS-97: Throat microphone
These items have IPX4* waterproof protection. When in use, the transceiver's waterproof rating meets IPX4 when they are connected.
* Once these items have been dropped, the IP rating cannot be guaranteed because of possible damage to these cases or the waterproof seal.

Some options may not be available in some countries. Please ask your dealer for details.
Approved Icom optional equipment is designed for optimal performance when used with an Icom transceiver.

FREQUENCY RANGE AND OUTPUT POWER

Model	Version	Frequency Range	Output Power
VHF P25 TRUNKING HANDHELD TRANSCEIVERS IC-F9011 series	-	136-174 MHz	6 W
UHF P25 TRUNKING HANDHELD TRANSCEIVERS IC-F9021 series IC-F9023 series	USA-16 EXP-16	450-520 MHz	5 W
	USA-17 EXP-17	380-470 MHz	

• Channel spacing:
12.5 kHz*/15 kHz*/25 kHz*3

*1 Except IC-F9011 series, *2 Only IC-F9011 series,

*3 Only EXP versions