



INSTRUCTION MANUAL

VHF MOBILE TRANSCEIVERS

IC-F5062

IC-F5062D

UHF MOBILE TRANSCEIVERS

IC-F6062

IC-F6062D



Icom Inc.

IMPORTANT

READ ALL INSTRUCTIONS carefully and completely before using the transceiver.

SAVE THIS INSTRUCTION MANUAL — This instruction manual contains important operating instructions for the **IC-F5062 and IC-F5062D VHF MOBILE TRANSCEIVERS, IC-F6062 and IC-F6062D UHF MOBILE TRANSCEIVERS.**

▨ See the operating guide for details of BIIS, MDC, LTR® and Digital system operations. Ask your dealer for details.

EXPLICIT DEFENITIONS

WORD	DEFINITION
⚠ WARNING!	Personal injury, fire hazard or electric shock may occur.
CAUTION	Equipment damage may occur.
NOTE	If disregarded, inconvenience only. No risk of personal injury, fire or electric shock.

About e-marking: Detailed installation notes for Icom mobile transceivers to be fitted into vehicles are available. Please contact your Icom dealer or distributor.

VOICE CODING TECHNOLOGY

The AMBE+2™ voice coding Technology embodied in this product is protected by intellectual property rights including patent rights, copyrights and trade secrets of Digital Voice Systems, Inc. This voice coding Technology is licensed solely for use within this Communications Equipment.

The user of this Technology is explicitly prohibited from attempting to extract, remove, decompile, reverse engineer, or disassemble the Object Code, or in any other way convert the Object Code into a human-readable form. U.S. Patent Nos.

#8,595,002, #8,359,197, #8,315,860, #8,200,497, #7,970,606, and #6,912,495 B2.

Icom is not responsible for the destruction, damage to, or performance of any Icom or non-Icom equipment, if the malfunction is because of:

- Force majeure, including, but not limited to, fires, earthquakes, storms, floods, lightning, other natural disasters, disturbances, riots, war, or radioactive contamination.
- The use of Icom transceivers with any equipment that is not manufactured or approved by Icom.

Icom, Icom Inc. and Icom logo are registered trademarks of Icom Incorporated (Japan) in Japan, the United States, the United Kingdom, Germany, France, Spain, Russia, Australia, New Zealand, and/or other countries.

LTR is a registered trademark of the E.F.Johnson Company.

All other products or brands are registered trademarks or trademarks of their respective holders.

PRECAUTIONS

⚠ WARNING! NEVER connect the transceiver to an AC outlet. This may cause a fire or an electric shock.

⚠ WARNING! NEVER connect the transceiver to a power source of more than 16 V DC such as a 24 V battery, or use reverse polarity. This could cause a fire or damage the transceiver.

⚠ WARNING! NEVER remove the fuse holders on the DC cable. This could cause a fire, electric shock and damage the transceiver.

⚠ WARNING! NEVER place the transceiver where normal operation of the vehicle may be hindered or where it could cause bodily injury.

⚠ WARNING! NEVER operate the transceiver during a lightning storm. It may result in an electric shock, cause a fire or damage the transceiver. Always disconnect the power source and antenna before a storm.

CAUTION: DO NOT leave the transceiver in an insecure place to avoid use by unauthorized persons.

CAUTION: DO NOT expose the transceiver to rain, snow or any liquids. They could damage the transceiver.

CAUTION: DO NOT use non-Icom microphones. Other microphones have different pin assignments and may damage the transceiver.

CAUTION: DO NOT place or leave the transceiver in areas with temperatures below -25°C or above $+55^{\circ}\text{C}$, or in areas subject to direct sunlight, such as the dashboard.

CAUTION: DO NOT operate the transceiver without running the vehicle's engine, during mobile operations. When the transceiver's power is ON and your vehicle's engine is OFF, the vehicle's battery will soon become exhausted.

CAUTION: DO NOT place the transceiver in excessively dusty environments, or in direct sunlight.

CAUTION: DO NOT place the transceiver against walls or put anything on top of the transceiver. This may overheat the transceiver.

CAUTION: DO NOT use harsh solvents such as benzene or alcohol when cleaning the transceiver. They will damage the transceiver's surfaces.

CAUTION: DO NOT operate the transceiver if it becomes hot after operating it continuously for long periods of time. This may damage the transceiver.

TABLE OF CONTENTS

IMPORTANT	i	3 CONNECTION AND MAINTENANCE	14–18
EXPLICIT DEFENITIONS	i	■ Rear panel connection	14
VOICE CODING TECHNOLOGY	i	■ Supplied Accessories	16
PRECAUTIONS.....	ii	■ Mounting the transceiver	16
1 PANEL DESCRIPTION.....	1–7	■ Antenna	17
■ Front panel	1	■ Fuse replacement	17
■ Function display	2	■ Cleaning	17
■ Assignable function keys.....	3	■ Options	18
2 BASIC OPERATION.....	8–13	4 INFORMATION.....	19
■ Turning ON the power	8	■ About CE and DOC.....	19
■ Selecting a channel.....	8	■ Disposal	19
■ Call procedure.....	9	■ Country code list	19
■ Receiving and transmitting.....	9		
■ User set mode.....	12		
■ Stun function	12		
■ Scrambler function	12		
■ Automatic Key Lock function	12		
■ Emergency transmission.....	13		
■ Priority A channel selection.....	13		
■ Power Off Emergency function.....	13		

■ Front panel

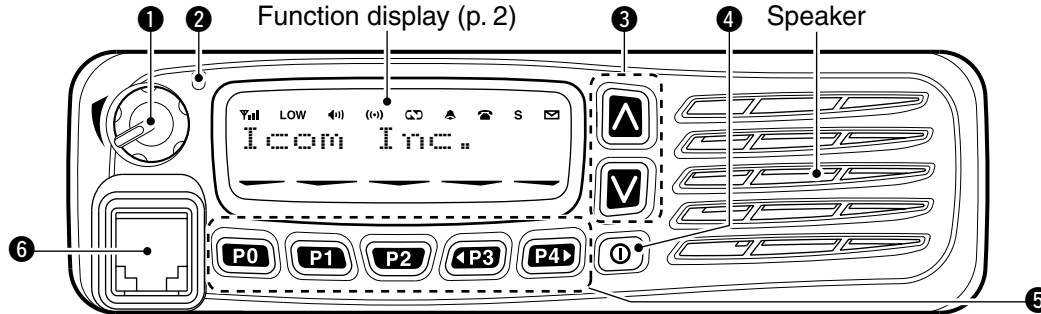

1 AF VOLUME CONTROL KNOB [VOL]

- Rotate to adjust the desired audio output level.
- The minimum audio level can be preset.

2 LED INDICATOR

- Lights red while transmitting.
- Lights green while receiving.

3 UP/DOWN KEYS [CH Up]/[CH Down]

- Push to select an operating channel, and so on.
- A desired function can be preset by your dealer. (p. 3)

4 POWER SWITCH [O]

- Hold down for 1 second to turn the power ON and OFF.
- Automatic scan start, Password prompt and Set mode access can be set to activate at power ON.

5 DEALER ASSIGNABLE KEYS

- Various functions can be preset by your dealer. (p. 3)

6 MICROPHONE CONNECTOR

- Connect the supplied or optional microphone.

CAUTION: DO NOT connect non-specified microphones. The pin assignments may be different and the transceiver may be damaged.

◇ MICROPHONE

The supplied or optional microphone has a PTT switch and a hanger hook.

- The following functions can be set for operation when the microphone is on or off hook (depending on the setting):
 - Automatic scan starts when it is ON hook.
 - Scan is cancelled when it is OFF hook.
 - Scan is paused when it is off hook.
 - Automatic priority channel selection is available when it is off hook.
 - Sets to 'Inaudible' (muted) mode when it is on hook.
 - Sets to 'Audible' (unmuted) mode when it is off hook.

1 PANEL DESCRIPTION

■ Function display

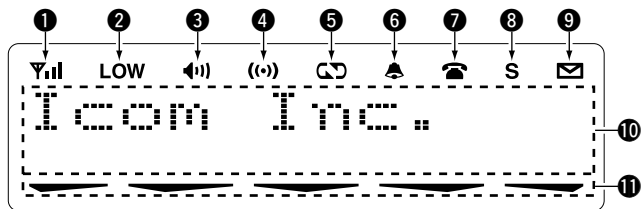

① SIGNAL STRENGTH INDICATOR

Displays relative signal strength level as shown below.



Weak ⇐ Receive Signal level ⇒ Strong

② LOW POWER INDICATOR

Displayed when low output power is selected.

③ AUDIBLE INDICATOR

➤ Displayed when the channel is in the 'audible' (unmute) condition.

➤ Displayed when the specified 2/5-Tone/BIIS*¹/MDC*² code is received.

④ COMPANDER INDICATOR

Displayed when the compander function is activated.

⑤ SCRAMBLER INDICATOR

Displayed when the voice scrambler function is activated.

⑥ BELL INDICATOR

Displayed or blinks when the specific 2/5-Tone/BIIS*¹/MDC*² code is received, according to the presetting.

⑦ CALL CODE MEMORY INDICATOR

- Displayed when the call code memory is selected.
- Displayed when a phone call is received.*³

⑧ SCROLL INDICATOR

Displayed when the SDM, includes more than 12 characters, is selected during the received message selection mode*¹.

⑨ SDM INDICATOR

Displayed when an SDM is received, or an SDM is selected for transmission.*¹

⑩ ALPHANUMERIC DISPLAY

- Displays an operating channel number, channel name, Set mode contents, DTMF code, etc.
- The indication mode can be selected from 1 line or 2 lines. Ask your dealer for details.
 - In this instruction manual, the LCD illustration is described using the 2 lines indication mode.

⑪ ACTIVATED KEY INDICATOR

Displayed above the key assigned as [Scan A Start/Stop], [Scan B Start/Stop], [Scan Add/Del(Tag)], [Lock], [Talk Around], [Surveillance] and [BIIS button]*¹ keys during that key is activated.

*¹ BIIS operation only

*² MDC operation only

*³ LTR® operation only

▨ See the operating guide for details of BIIS, MDC, LTR® and Digital system operations. Ask your dealer for details.

■ Assignable function keys

The following functions can be assigned to the [UP], [DOWN], [P0], [P1], [P2], [P3] and [P4] assignable function keys.

Consult your Icom dealer or system operator for details concerning your transceivers presetting.

If the preset function names are bracketed in the following explanations, the specific key is used to activate the function, depending on the presetting.

/// INFORMATION:

Depending on the presetting, the preset function for [P0], [P1], [P2] or [P3] is assigned to [A], [B], [C] or [D] of the optional HM-152T, respectively. Ask your dealer for details.

CH UP AND DOWN KEYS

- Push to select an operating channel.
- Push to select a transmit code channel after pushing [TX Code CH Select].
- Push to select a DTMF channel after pushing [DTMF Audial].
- Push to select a scan group after holding down [Scan A Start/Stop]/[Scan B Start/Stop] for 1 second.

ZONE KEY

Push this key, then select the desired zone using [CH Up]/[CH Down].

/// **What is “zone”?**—The desired channels are assigned to a zone according to the intended use. For example, ‘Staff A’ and ‘Staff B’ are assigned to a “Business” zone, and ‘John’ and ‘Cindy’ are assigned to a “Private” zone.

ZONE UP AND DOWN KEYS

Push to select an operating zone.

SCAN KEY

- Push to start and cancel a scan.
 - When the Power ON Scan function is activated, push to pause the scan. The paused scan resumes after the specified time period has passed.
- Hold down this key for 1 second to display the scan list, then push [CH Up] or [CH Down] to select the desired list.

1 PANEL DESCRIPTION

SCAN ADD/DEL (TAG) KEY

- Push to add or delete the selected channel to/from the scan group.
 1. Push to display the scan group, then push [CH Up] or [CH Down] to select the desired group.
 2. Push to add or delete the channel to/from the selected scan group.
 3. Hold down for 1 second to exit the scan group selection mode.
- Push this key while the scan is paused (a signal is detected) on a channel (except for priority channel,) and the channel is cleared from the scan group.

⚡ Depending on the setting, the cleared channel is added to the scan group again after the scan is cancelled.

PRIO A/B KEYS

- Push to select Priority A or Priority B channel.
- Hold down [Prio A (Rewrite)] or [Prio B (Rewrite)] for 1 second to rewrite the operating channel as the Priority A or Priority B channel.

MR-CH 1/2/3/4 KEYS

Push to select the memory channel 1 to 4 directly.

MONI (AUDI) KEY

- Push to mute and release the CTCSS (DTCS) or 2-Tone squelch mute. Open any squelch/deactivate any mute while holding down this key. (Only in the LMR mode)
- Activates one of (or two of) the following functions on each channel independently. (Only in the PMR mode)
 - While holding down, audio is emitted ('Audible' mode).
 - Push to mute the channel ('Inaudible' mode).
 - Push to unmute the channel ('Audible' mode).
 - After the communication is finished, push to send a 'reset code'. (5-Tone/BIIS operation only)

⚡ **NOTE:** The 'Audible' (unmute) mode may automatically return to the 'Inaudible' (mute) mode after a specified period, depending on the presetting.

PUBLIC ADDRESS KEY

Push to activate the Public Address (PA) function for voice amplification. When the PA function is activated, the audio output can be separately controlled from the transceiver with [CH Up]/[CH Down].

- This function is usable when an external unit, such as a audio amplifier, speaker, and so on, is connected.
- Push this key, then speak into the microphone while holding down [PTT].

RX SPEAKER KEY

Push to turn the RX speaker function ON or OFF.

When the RX speaker function is turned ON, the received audio can be heard via the external speaker.

- This function is available when the external speaker is additionally connected.
- This function is useful when you are out of the vehicle.
- The audio output level is linked to the transceiver's volume control.

LIGHT KEY

Push to turn ON the transceiver's backlight for about 5 seconds when the backlight function is turned OFF in user set mode.

LOCK KEY

Hold down to electronically lock all programmable keys except the following:

[Moni(Audi)], [Light], [Lock], [Call] (incl. Call A and Call B), [Emergency Single], [Surveillance], [Lone Worker] and [OPT 1/2/3].

LONE WORKER KEY

Push to turn the Lone Worker function ON or OFF.

- If the Lone Worker function is activated, the Emergency function is automatically turned ON after the specified time period has passed with no operation is performed.

HIGH/LOW KEY

Push to select the transmit output power temporarily or permanently, depending on the presetting.

- Ask your dealer for the output power level for each selection.

TONE/RAN CH SELECT KEY

- While in analog mode operation, push to enter the continuous tone channel selection mode. Then select the desired tone frequency/code setting with [CH Up] or [CH Down]. After the selection, push this key again to set.
- While in digital mode operation*, push to enter the RAN channel selection mode. Then select the desired RAN setting with [CH Up] or [CH Down]. After the selection, push this key again to set.
- While in mixed (digital and analog) mode operation*, push to enter the continuous tone channel selection mode. Then select the desired tone frequency/code setting with [CH Up] or [CH Down]. After the selection, push this key to set. After that, the RAN channel selection screen appears. Select the desired RAN setting with [CH Up] or [CH Down]. After the selection, push this key again to set.

* Depending on version, digital and mixed (digital and analog) mode operations are available only when the optional UT-126H DIGITAL MODULATOR/DEMODULATOR UNIT is installed. Ask your dealer for details.

C.TONE CH ENT KEY

Push to enter the continuous tone channel selection mode. Then select the desired tone frequency/code setting with [CH Up] or [CH Down]. The selected channel remains set as the continuous tone channel until another channel is designated as such.

1 PANEL DESCRIPTION

TALK AROUND KEY

Push to turn the talk around function ON or OFF.

- The talk around function equalizes the transmit frequency to the receive frequency for transceiver-to-transceiver communication.

WIDE/NARROW KEY

Push to toggle the IF bandwidth between wide and narrow.

- The wide passband width can be set to 25.0 or 20.0 kHz using the CS-F3160/F5060 CLONING SOFTWARE. (PMR operation only) Ask your dealer for details.

DTMF AUTODIAL KEY

Push to enter the DTMF channel selection mode. Then select the desired DTMF channel using [CH Up]/[CH Down].

After selecting the DTMF channel, push again to transmit the selected DTMF code.

RE-DIAL KEY

Push to transmit the last-transmitted DTMF code.

- TX memories are cleared after turning the transceiver OFF.

CALL KEYS

Push to transmit a 2/5-Tone/BIIS ID code.

- Call transmission is necessary before calling another station depending on your signalling system.
- [Call A] and/or [Call B] may be available when your system employs selective 'Individual/Group' calls. Ask your dealer which call is assigned to each key.

EMERGENCY KEY

Hold down for a preset time period to transmit the emergency call.

- The emergency call transmits with beeps and the preset emergency text display.
- The transceiver can transmit the emergency call silently and with no emergency text display, depending on the presetting. Ask your dealer for details.
- If you want to cancel the emergency call, hold down the key again before transmitting the call.
- The emergency call is transmitted one time only or repeatedly until receiving a control code, depending on the presetting.

SURVEILLANCE KEY

Push to turn the surveillance function ON or OFF.

When this function is turned ON, the beep is not heard and the LCD backlight and the LED indicator do not light when a signal is received or a key is pushed.

TX CODE ENTER KEY (PMR operation only)

Push to enter the ID code edit mode directly, for both 5-Tone and MSK. Then set the desired digit using [CH Up]/[CH Down]. (p. 11)

TX CODE CHANNEL SELECT KEY

- ➔ Push to enter the ID code channel selection mode directly. Then set the desired channel using [CH Up]/[CH Down]. (p. 10)
- ➔ During ID code channel selection mode, hold down for 1 second to enter the ID code edit mode for 5-Tone and MSK. Then set the desired digit using [CH Up]/[CH Down]. (p. 11)

TX CODE CHANNEL UP/DOWN KEYS

Push to select a TX code channel directly.

SCRAMBLER/ENCRYPTION KEY

- While in analog mode operation, push to toggle the voice scrambler function ON and OFF.
- While in digital mode operation*, push to toggle the encryption transmission function ON and OFF.

* Depending on version, digital mode operation is available only when the optional UT-126H DIGITAL MODULATOR/DEMODULATOR UNIT is installed. Ask your dealer for details.

COMPANDER KEY

Push to toggle the compander function ON and OFF. The compander function reduces noise components from the transmitted audio to provide clear communication.

ID-MR SELECT KEY (PMR operation only)

- Recalls detected ID codes.
 - Push this key, then select the ID code using [CH Up]/[CH Down].
 - Up to 5 ID's are memorized.
- Hold down for 1 second to erase the selected ID's.

HOOK SCAN KEY

When the on hook scan function is activated, push this key to disables on hook scan function (stop scanning) temporarily. Push this key again to re-start scanning.

USER SET MODE KEY

- Hold down for 1 second to enter user set mode.
 - During in the user set mode, push this key to select an item that is enabled by your dealer, and change the value or condition by pushing [CH Up] or [CH Down].
- Hold down for 1 second again to exit user set mode.

10Key ENT KEY

Push to enable the connected microphone's 10-keypad operation.

- The desired memory channel, TX code channel (5-Tone), ID list number (digital), TX status (MSK/Digital) or Short Data Message (digital) can be selected. (Depends on the pre-programming.)

OPT 1/2/3 KEYS

Push to control the output signal level from the optional unit connector.





POWER OFF EMERGENCY

While holding down this key, turn the transceiver's power OFF to activate the Power OFF Emergency function.

After the specified time period has passed, from the time this function is activated, the emergency call is transmitted with no beep emission and no display indication. (p. 13)

■ Turning ON the power

- ① Hold down [⓪] for 1 second to turn the power ON.
- ② If the transceiver is set for a start up password, enter the digit codes as directed by your dealer.
 - The keys as below can be used for password entry:
The transceiver detects numbers in the same block as identical. Therefore “01234” and “56789” are the same.

KEY					
NUMBER	0 5	1 6	2 7	3 8	4 9

- ③ When “PASSWORD” does not clear after inputting 6 digits, the entered code number may be incorrect. Turn OFF the power and enter the password again.

■ Selecting a channel

Several types of channel selections can be used. The types may differ according to your system set up.

NON-ZONE TYPE:

To select the operating channel:

- Push [CH Up] or [CH Down].
- Push one of [MR-CH 1] to [MR-CH 4].

ZONE TYPE:

To select the zone:

- Push [Zone], then push [CH Up] or [CH Down].
- Push [Zone Up] or [Zone Down].

◇ **Voting operation**

The transceiver automatically starts scanning when a zone, specified for the voting operation, is selected.

The voting scan detects the signal strength of the repeater and automatically selects the strongest station.

AUTOMATIC SCAN TYPE:

Channel setting is not necessary for this type. When turning ON power, the transceiver automatically starts scanning. Scanning stops when a call is received.

■ Call procedure

When your system employs tone signaling (excluding CTCSS and DTCS), a call procedure may be necessary prior to voice transmission. The tone signalling employed may be a selective calling system which allows you to call specific station(s) only and prevent unwanted stations from contacting you.

- ① Select the desired TX code channel or 2/5-Tone code according to your System Operator's instructions.
 - This may not be necessary depending on programming.
 - Refer to pages 10 and 11 for selection.
- ② Push [Call] (assigned to one of the dealer programmable keys).
- ③ After transmitting, the remainder of your communication can be carried out in the normal fashion.

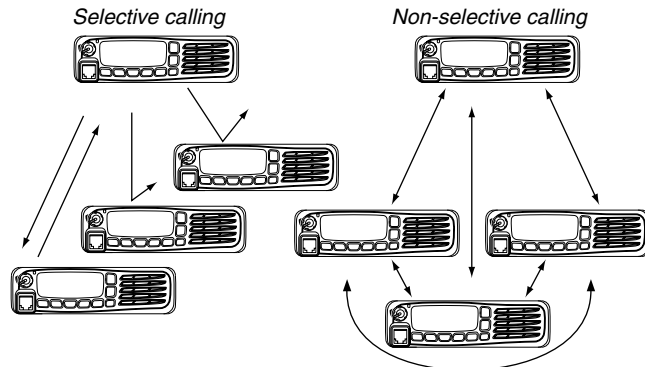

■ Receiving and transmitting

Receiving:

- ① Hold down [Ⓚ] for 1 second to turn the power ON.
- ② Push [CH Up] or [CH Down] to select the conventional system channel, in sequence.
- ③ When receiving a call, rotate [VOL] to adjust the audio output level to a comfortable listening level.

Transmitting:

Wait for the channel to become clear to avoid interference.

- ① Take the microphone off hook.
 - 2/5-Tone mute may be released. (The 'audible' condition is selected and BUSY indicator lights green.)
 - A priority channel may be selected automatically.
- ② Wait for the channel to become clear.
 - The channel is busy when BUSY indicator lights green.
- ③ While holding down [PTT], speak into the microphone at your normal voice level.
- ④ Release [PTT] to return to receive.

- IMPORTANT:** To maximize the readability of your signal;
1. Pause briefly after pushing [PTT].
 2. Hold the microphone 5 to 10 cm (2 to 4 inches) from your mouth, then speak at a normal voice level.

2 BASIC OPERATION

■ Receiving and transmitting (Continued)

◇ Transmitting notes

• Transmit inhibit function

The transceiver has several inhibit functions which restrict transmission under the following conditions:

- The channel is in mute condition ('Inaudible' condition; "🔇") (Audible indicator) is not displayed.)
- The channel is busy.
- Un-matched (or matched)* CTCSS is received.
*Depending on the pre-setting
- The selected channel is a 'receive only' channel.

• Time-out timer

After continuous transmission for the pre-programmed time period, the time-out timer is activated, causing the transceiver to stop transmitting.

• Penalty timer

Once the time-out timer is activated, transmission is further inhibited for a period determined by the penalty timer.

◇ TX code channel selection

If the transceiver has [TX Code CH Select] assigned to it, the indication can be toggled between the operating channel number (or name) and TX code channel number (or name). When the TX code channel number (or name) is displayed, [CH Up] or [CH Down] selects the TX code channel.

USING [TX CODE CH SELECT] KEY:

- ① Push [TX Code CH Select]— a TX code channel number (or name) appears.
- ② Push [CH Up] or [CH Down] to select the desired TX code channel.
- ③ After selecting, push [TX Code CH Select] to set.
 - Return to the Standby mode.
- ④ Push [Call] to transmit the selected TX code.

USING [TX CODE CH UP]/[TX CODE CH DOWN] KEY:

If the transceiver has a [TX Code CH Up] or [TX Code CH Down] key assignment, the programmed TX code channel can be selected directly when pushed.

◇ TX code number edit (PMR operation only)

If the transceiver has [TX Code CH Select] or [TX Code Enter] assigned to it, TX code contents can be edited within the allowable digits.

USING [TX CODE CH SELECT] KEY:

- ① Push [TX Code CH Select] to enter the TX code channel selection mode.
 - Select the desired channel before entering the TX code channel selection mode if necessary.
- ② Hold down [TX Code CH Select] for 1 second to enter the TX code edit mode.
 - The digit to be edited blinks.
- ③ Push [TX Code CH Select] to select the desired digit to be edited.
- ④ Push [CH Up] or [CH Down] to set the desired digit.
- ⑤ Push [TX Code CH Select] to set. The digit to the right will blink automatically.
- ⑥ Repeat steps ④ and ⑤ to edit all allowable digits.
- ⑦ After editing, push [TX Code CH Select] to set.
 - Return to the Standby mode.
- ⑧ Push [Call] to transmit.

USING [TX CODE ENTER] KEY:

- ① Push [TX Code Enter] to enter the TX code edit mode.
 - The editable digit to be edited blinks.
- ② Push [TX Code Enter] to select the desired digit to be edited.
- ③ Push [CH Up] or [CH Down] to select the desired digit.
- ④ Push [TX Code Enter] to set. The digit to the right will blink automatically.
- ⑤ Repeat steps ③ and ④ to input all allowable digits.
- ⑥ After editing, push [TX Code Enter] to set.
 - Return to the Standby mode.
- ⑦ Push [Call] to transmit.

◇ DTMF transmission

If the transceiver has [DTMF Autodial] assigned to it, the automatic DTMF transmission function is available. Up to 8 DTMF channels are available.

- ① Push [DTMF Autodial]— a DTMF channel appears.
- ② Push [CH Up] or [CH Down] to select the desired DTMF channel.
- ③ Push [DTMF Autodial] to transmit the DTMF code.

2 BASIC OPERATION

■ User set mode

The User Set mode allows you to set seldom-changed settings. If the transceiver has [User Set Mode] assigned to it, you can customize the transceiver operation to suit your preferences and operating style.

Entering the User Set mode

- ① Hold down [User Set Mode] for 1 second.
 - Enters the User Set mode.
- ② Push [User Set Mode] one or more times to select a desired item.
 - The selectable items differ, depending on the presetting.
 - The selectable items are **Backlight**, **LCD Contrast**, **Beep**, **Beep Level**, **Ringer Level**, **SQL Level**, **AF Min Level**, **Mic Gain**, **Battery Voltage**, **Horn**, **Signal Moni**, **Lone Worker** and **System Info**.
- ③ Push [CH Up] or [CH Down] to set the desired level or condition.
- ④ Hold down [User Set Mode] for 1 second again.
 - Exits the User Set mode.



■ Stun function

When the specified ID, set as a kill ID, is received, the stun function is activated.

When the kill ID is received, the transceiver switches to the password required condition. Entering of the password is necessary to operate the transceiver again in this case. (p. 8)

■ Scrambler function

The voice scrambler function provides private communication between stations. All versions have a built-in frequency inversion type scrambler; however, an optional rolling or nonrolling type is available as well.

- ① Push [Scrambler] to turn the scrambler function ON.
 - Displays “.
- ② Push [Scrambler] again to turn the scrambler function OFF.
 - Displays “.

■ Automatic Key Lock function

When [Lock] is assigned to any key and the Automatic Key Lock timer is pre-programmed* by your dealer, the key lock function can be automatically turned ON after the specified time period has passed without operation during Standby condition.

While the lock function is ON, hold down [Lock] for 1 second to turn the function OFF.

*When “0” is programmed, this function is not available.

■ Emergency transmission

When [Emergency] is pushed for the specified time period, an emergency signal is automatically transmitted. (p. 6)

When [Emergency] is pushed for the specified time period, the DTMF or 5-Tone* emergency signal is transmitted once or repeatedly on the emergency channel. However, when no emergency channel is specified, the signal is transmitted on the previously selected channel.

If you want to cancel the emergency call, hold down the key again before transmitting the call.

◇ NOTES

Depending on the presetting, the following functions are automatically activated. Ask your dealer for details.

• Auto TX function

After the emergency call transmission, audio from the microphone is automatically transmitted for a specified time period.*

• Auto RX function

After the emergency call transmission, the transceiver stands by in the audible mode for the specified time period.*

* Depending on the operating model type.

■ Priority A channel selection

When one of the following operations is performed, the transceiver selects the Priority A channel automatically.

- Turning the power ON
The Priority A channel is selected each time the transceiver power is turned ON.
- Status call
The Priority A channel is selected when transmitting a status call. (BIIS operation only)
- Off hook.
The Priority A channel is selected when the microphone is took off from its hanger.

■ Power Off Emergency function

If the new function key, [Power OFF Emergency], is assigned to any key, you can use the Power OFF Emergency function. To activate the Power OFF Emergency function, turn the transceiver's power OFF while holding down [Power OFF Emergency].

After the specified time period has passed, from the time this function is activated, the emergency call is transmitted (with no beep emission and no display indication).

If you want to cancel the emergency call, turn the transceiver's power ON.

And also, depending on the pre-setting, the Remote Monitor function can be used while this function is activated.

■ Rear panel connection

◇ For mobile operation

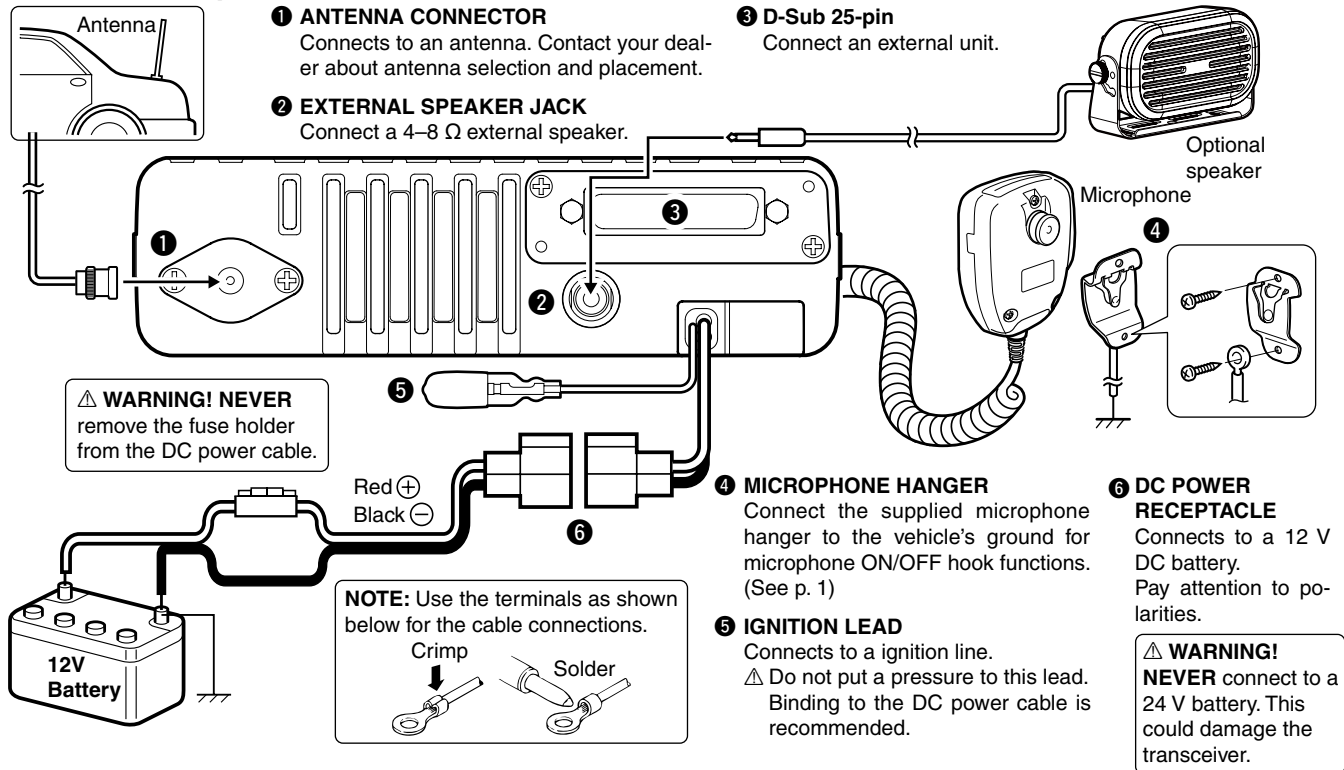

■ Rear panel connection (Continued)

◇ For base station operation

To the antenna

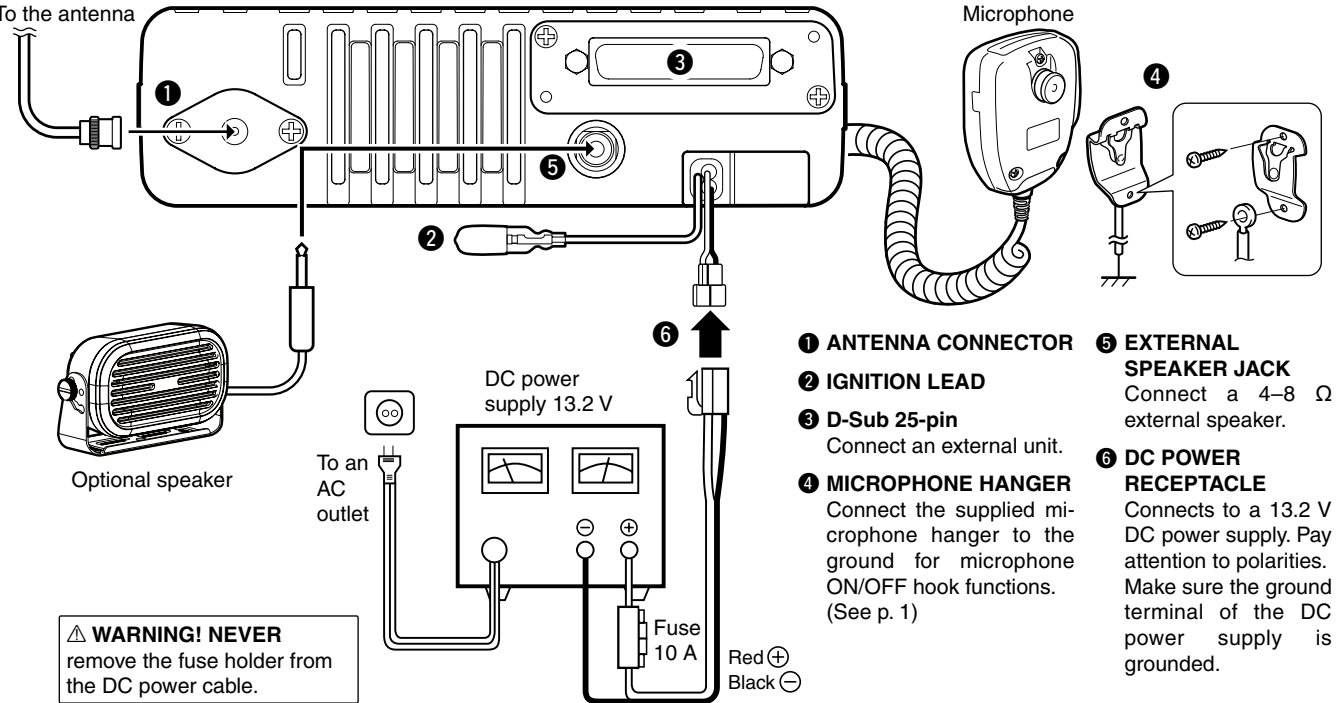









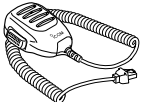

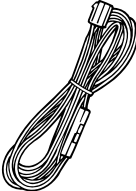
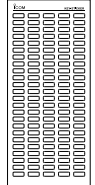
⚠ WARNING! NEVER remove the fuse holder from the DC power cable.

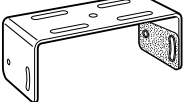
- 1 ANTENNA CONNECTOR**
- 2 IGNITION LEAD**
- 3 D-Sub 25-pin**
Connect an external unit.
- 4 MICROPHONE HANGER**
Connect the supplied microphone hanger to the ground for microphone ON/OFF hook functions. (See p. 1)
- 5 EXTERNAL SPEAKER JACK**
Connect a 4–8 Ω external speaker.
- 6 DC POWER RECEPTACLE**
Connects to a 13.2 V DC power supply. Pay attention to polarities. Make sure the ground terminal of the DC power supply is grounded.

3 CONNECTION AND MAINTENANCE

■ Supplied Accessories

Microphone 	Microphone hanger and screw set 	Microphone hanger cable 
DC power cable 	Function name stickers*1 	Sponges*2 
Mounting bracket 	Flat washers 	Bracket bolts 
	Spring washers 	Mounting screws (M5×12) 
	Nuts 	Self-tapping screws (M5×16) 

*1 Used for labelling the programmable function keys according to their assigned functions.

*2 Used for the optional unit installation. Ask your dealer for details.

■ Mounting the transceiver

The universal mounting bracket supplied with your transceiver allows overhead mounting.

- Mount the transceiver securely with the 4 supplied screws to a thick surface which can support more than 1.5 kg.

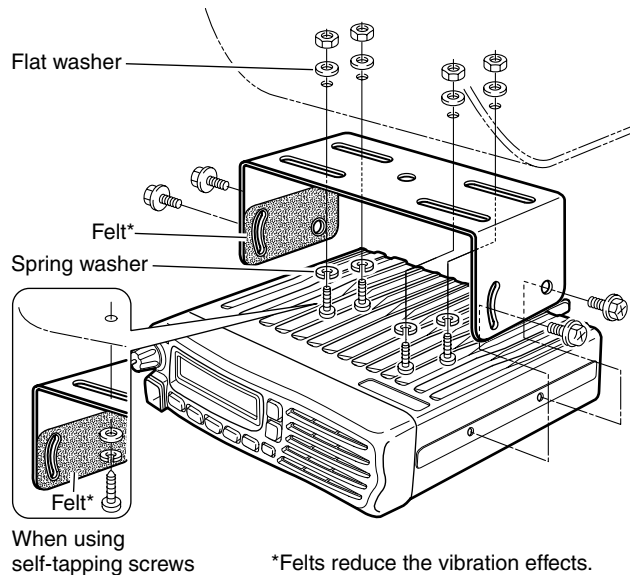

■ Antenna

A key element in the performance of any communication systems is an antenna. Contact your dealer about antennas and the best places to mount them.

■ Fuse replacement

A fuse is installed in the fuse holder of the supplied DC power cable. If a fuse blows or the transceiver stops functioning, track down the source of the problem if possible, and replace the damaged fuse with a new rated one.

□ Fuse rating: 10 A

USE the 10 A fuse only.

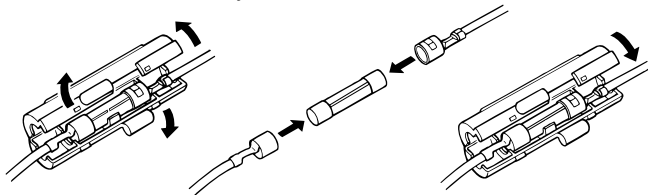

■ Cleaning

If the transceiver becomes dusty or dirty, wipe it clean with a soft and dry cloth.



DO NOT use solvents such as benzene or alcohol, as they may damage the transceiver surfaces.

3 CONNECTION AND MAINTENANCE

■ Options

- **RMK-3** SEPARATION KIT + **OPC-609** SEPARATION CABLE
Allows you to install the transceiver main unit separately from the front panel for operating convenience.
- **HM-152/HM-152T/HM-148G/HM-148T** HAND MICROPHONES
HM-152 : Hand microphone
HM-152T : DTMF microphone
HM-148G: Self ground heavy duty microphone
HM-148T : Self ground heavy duty DTMF microphone
The 10-keypad of this microphone can be used for the DTMF code transmission only.
- **SM-26** DESKTOP MICROPHONE
- **SP-30/SP-35/SP-35L** EXTERNAL SPEAKERS
Input impedance: 4 Ω
Rated input: 5 W (SP-35/SP-35L), 20 W (SP-30)
Maximum input: 7 W (SP-35/SP-35L), 30 W (SP-30)

- **UT-109R/UT-110R** SCRAMBLER UNITS
Non-rolling type (UT-109R)/Rolling type (UT-110R) voice scrambler unit provides higher communication security.
- **UT-126H** DIGITAL MODULATOR/DEMODULATOR UNIT
Provides 6.25 kHz digital mode operation.
(UT-126H is a upgrade version of UT-119H. UT-119H can be used depending on the version. Ask your dealer for details.)

Some options may not be available in some countries. Please ask your dealer for details.

■ About CE and DOC

CE Hereby, Icom Inc. declares that the versions of IC-F5062/IC-F5062D/IC-F6062/IC-F6062D which have the “CE” symbol on the product, comply with the essential requirements of the Radio Equipment Directive, 2014/53/EU, and the restriction of the use of certain hazardous substances in electrical and electronic equipment Directive, 2011/65/EU. The full text of the EU declaration of conformity is available at the following internet address:
<http://www.icom.co.jp/world/support>

3
4

■ Disposal



The crossed-out wheeled-bin symbol on your product, literature, or packaging reminds you that in the European Union, all electrical and electronic products, batteries, and accumulators (rechargeable batteries) must be taken to designated collection locations at the end of their working life. Do not dispose of these products as unsorted municipal waste. Dispose of them according to the laws in your area.

Count on us!

A6566D-1EU-7a
Printed in Japan
© 2007–2018 Icom Inc.

Printed on recycled paper with soy ink.

Icom Inc.

1-1-32 Kamiminami, Hirano-ku, Osaka 547-0003, Japan