

ICOM

INSTRUCTION MANUAL

PMR446 FM TRANSCEIVER

IC-F25SR



Icom Inc.

IMPORTANT

READ ALL INSTRUCTIONS carefully and completely before using the transceiver.

SAVE THIS INSTRUCTION MANUAL— This instruction manual contains important operating instructions for the **IC-F25SR** PMR446 FM TRANSCEIVER.

EXPLICIT DEFINITIONS

WORD	DEFINITION
⚠ WARNING	Personal injury, fire hazard or electric shock may occur.
CAUTION	Equipment damage may occur.
NOTE	If disregarded, inconvenience only. No risk of personal injury, fire or electric shock.

Icom, Icom Inc. and the  ICOM logo are registered trademarks of Icom Incorporated (Japan) in the United States, the United Kingdom, Germany, France, Spain, Russia and/or other countries.

All other products or brands are registered trademarks or trademarks of their respective holders.

PRECAUTIONS

⚠ CAUTION! NEVER hold the transceiver so that the antenna is very close to, or touching exposed parts of the body, especially the face or eyes, while transmitting. The transceiver will perform best if the microphone is 5 to 10 cm away from the lips and the transceiver is vertical.

⚠ CAUTION! NEVER operate the transceiver with a headset or other audio accessories at high volume levels.

⚠ CAUTION! NEVER short the terminals of the battery pack.

DO NOT push [PTT] when not actually desiring to transmit.

AVOID using or placing the transceiver in direct sunlight or in areas with temperatures below -25°C or above $+55^{\circ}\text{C}$.

The basic operations, transmission and reception of the transceiver are guaranteed within the specified operating temperature range.

DO NOT modify the transceiver for any reason.

Optional unit installation should be done at an authorized Icom service center only.

KEEP the transceiver from heavy rain, and **never** immerse it in the water. The transceiver construction is **water resistant**, not waterproof.

The use of non-Icom battery packs/chargers may impair transceiver performance and invalidate the warranty.

DOC



CE versions of the IC-F25SR which display the "CE" symbol on the serial number seal, comply with the essential requirements of the European Radio and Telecommunication Terminal Directive 1999/5/EC.

 ICOM

DECLARATION OF CONFORMITY

We Icom Inc. Japan
1-1-32, Kamiminami, Hirano-ku
Osaka 547-0003, Japan

CE0168

Declare on our sole responsibility that this equipment complies with the essential requirements of the Radio and Telecommunications Terminal Equipment Directive, 1999/5/EC, and that any applicable Essential Test Suite measurements have been performed.

Düsseldorf 14th Jul. 2006
Place and date of issue

Kind of equipment: UHF PMR TRANSCEIVER

Type-designation: IC-F25SR

Icom (Europe) GmbH
Himmelgeisterstraße 100
D-40225 Düsseldorf

Authorized representative name

Version (where applicable):

This compliance is based on conformity with the following harmonised standards, specifications or documents:

H. Ikegami
General Manager

- i) EN 60950-1 2001
- ii) EN 300 296-2 (March 2001)
- iii) EN 301 489-1 V1.4.1 (August 2002)
- iv) EN 301 489-5 V1.3.1 (August 2002)
- v) _____
- vi) _____
- vii) _____

Signature

Icom Inc.

TABLE OF CONTENTS

IMPORTANT	i
EXPLICIT DEFINITIONS	i
PRECAUTIONS	ii
DOC	iii
TABLE OF CONTENTS	iv
1 ACCESSORIES	1-4
■ Supplied accessories	1
■ Accessory attachments	2
2 PANEL DESCRIPTION	5-8
■ Front, top and side panels	5
■ LED indicator	7
■ Programmable function keys	8
3 BASIC OPERATION	9-17
■ Receiving and transmitting	9
■ Setting the squelch level	11
■ Auto scan function	11
■ Battery type selection	12
■ Setting the group code number	13
■ Find scan operation	17
4 RINGER FUNCTION	18-20
■ Call-Ring operation	18
■ Smart-Ring operation	19
5 OTHER FUNCTIONS	21-23
■ Monitor audible function	21
■ Time-Out Timer	21
■ Power save function	22
■ Low battery indication	22
■ Scrambler function.....	23
■ All reset function	23
6 BATTERY CHARGING	24-32
■ Caution	24
■ Battery chargers.....	27
7 BATTERY CASE.....	33-34
■ Optional battery case (BP-240)	33
8 SWIVEL BELT CLIP	35-38
■ MB-93 contents	35
■ Attaching	35
■ Detaching	37
9 OPTIONS	39-40
10 SPECIFICATIONS	41-42

1 ACCESSORIES

■ Supplied accessories

Battery pack

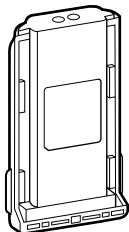

Battery charger

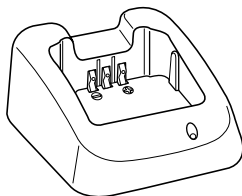

Belt clip



Jack cover
(with screws)

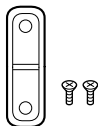

AC adapter*¹
(for the battery charger)

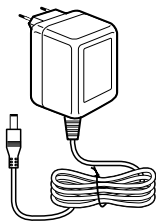

Unit cover*²
(double-sided tape)



*¹ Depends on version.

*² Use the unit cover as a spare.
Ask your dealer for details.

■ Accessory attachments

◇ Battery pack

To attach the battery pack:

Slide the battery pack in the direction of the arrow (1), then lock it with the battery release button.

- Slide the battery pack until the battery release button makes a 'click' sound.

To release the battery pack:

Push the battery release button in the direction of the arrow (2). Then slide the battery pack in the direction opposite to the arrow (1).

NEVER release or attach the battery pack when the transceiver is wet or soiled. This may result in water or dust getting into the transceiver/battery pack and may result in the transceiver being damaged.

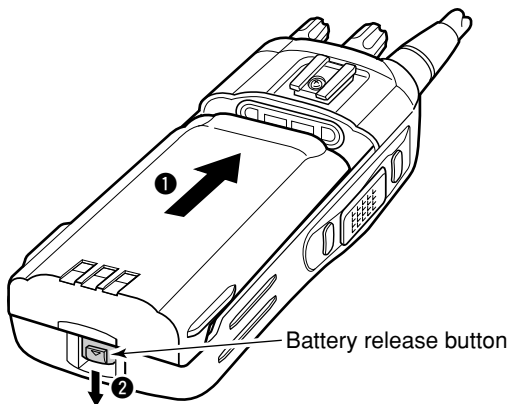

1 ACCESSORIES

◆ Belt clip

To attach the belt clip:

- ① Release the battery pack if it is attached.
- ② Slide the belt clip in the direction of the arrow until the belt clip is locked and makes a 'click' sound.

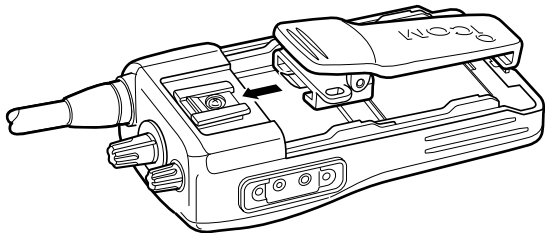

To detach the belt clip:

- ① Release the battery pack if it is attached.
- ② Pinch to lift the clip (①), and slide the belt clip in the direction of arrow (②).

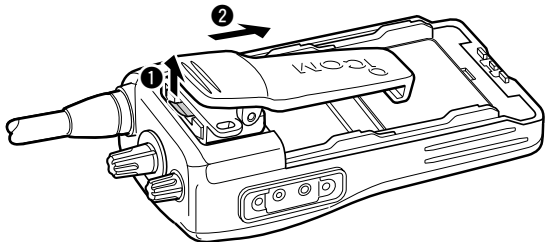

◇ Jack cover

Attach the jack cover when the optional speaker-microphone or headset is not used.

To attach the jack cover:

- 1 Attach the jack cover to the [MIC/SP] jack.
- 2 Tighten the screws using a Phillips screwdriver.

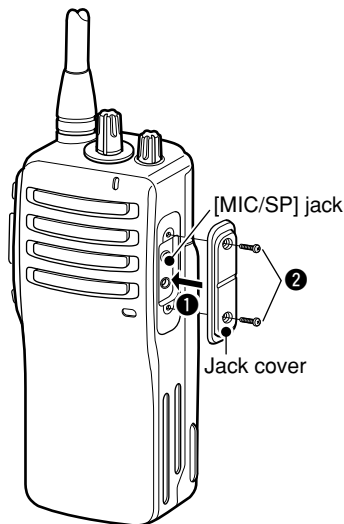

To detach the jack cover:

- 1 Unscrew the screws using a Phillips screwdriver.
- 2 Detach the jack cover for the optional speaker-microphone or headset connection.

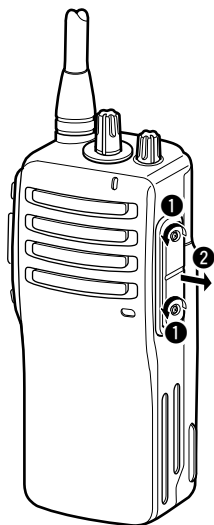

⚠ **CAUTION!**: Use the supplied screws only.

2 PANEL DESCRIPTION

■ Front, top and side panels

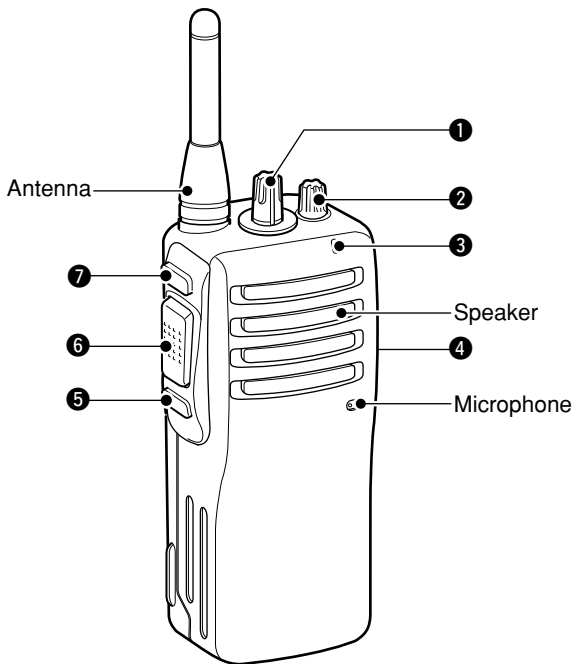

① CHANNEL SELECTOR [CH selector]

Rotate to select the pre-programmed memory channels.

② VOLUME CONTROL [VOL]

Rotate to turn the power ON/OFF and adjust the audio level.

3 LED INDICATOR (p. 7)

- ➔ Lights red while transmitting.
- ➔ Lights green while receiving a signal, or when the squelch is open.
- ➔ Blinks orange after transmitting/receiving a Smart-Ring call.
- ➔ Blinks green to indicate the low battery condition.

4 EXTERNAL MICROPHONE/SPEAKER JACK [MIC/SP]

Connect an optional speaker-microphone or headset.

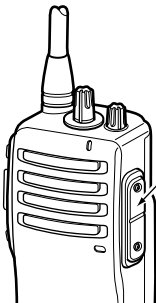

Jack cover

NOTE: Attach the jack cover when optional equipment is not used.

See page 4 for details.

5 PROGRAMMABLE KEY [Lower]

The desired function can be assigned. (p. 8)

6 PTT SWITCH [PTT]

Push and hold to transmit; release to receive.

7 PROGRAMMABLE KEY [Upper]

The desired function can be assigned. (p. 8)

■ LED indicator

The LED indicator indicates the information as follows;

(Ref.; R=Red, G=Green, O=Orange)

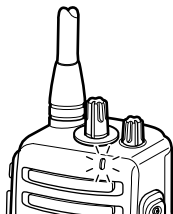

- TX: Turns Red while transmitting a signal.



- RX: Turns Green while receiving a signal.



- Call LED (Blink): Transmitting or receiving the Smart-Ring.



- Auto/Find scan: Blinks while Auto/Find scan is activated.

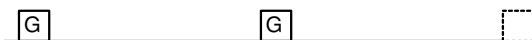

- Low BATT1: You should charge the battery. (blinks slowly)



- Low BATT2: You must charge the battery. (blinks fast)

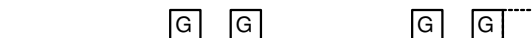

- TX low BATT1: Low BATT1 was detected during TX mode.



- TX low BATT2: Low BATT2 was detected during TX mode.



* During the alkaline battery operation.

■ Programmable function keys

The desired key function can be assigned to **[Upper]** and **[Lower]** in following way.

2

- ① Turn power OFF in advance.
- ② Rotate **[CH selector]** to select channel 16.
- ③ Rotate **[VOL]** to turn power ON while pushing and holding the desired key, **[Upper]** or **[Lower]**, to be assigned.
 - The beep is emitted depending on the selected function as below.

[Smart Ring/Ringer]	1 high beep is emitted.
[Moni]	2 high beeps are emitted.
[Scrambler]	3 high beeps are emitted.
[Null]	1 high beep is emitted for 1 sec.

- ④ Turn power OFF.
- ⑤ Repeat steps ③ and ④ until the desired key function is assigned.

NULL KEY

No function.

SMART RING/RINGER KEY

- Push to send a Smart-Ring call.
- Push and hold for 1 sec. to send a Call-Ring.

MONITOR KEY

- Push to mute the CTCSS (or DTCS) squelch mute.
- Push and hold for 1 sec. to release the CTCSS (or DTCS) squelch mute.
- Open any squelch/deactivate any mute while pushing and holding this key.

VOICE SCRAMBLER FUNCTION KEY

- Push to turn the voice scrambler function OFF.
- Push and hold for 1 sec. to turn the voice scrambler function ON.

3 BASIC OPERATION

■ Receiving and transmitting

/// Prior to using the transceiver for the first time, the battery pack must be fully charged for optimum life and operation. (P. 24)

Receiving:

- ① Rotate **[VOL]** clockwise to turn power ON.
- ② Rotate **[CH selector]** to select the desired operating channel.
 - Set your group code number if required. (pgs. 13–16)
 - Scan starts automatically when channel 16 is selected. (p. 11)
- ③ Listen for a transmission and adjust **[VOL]** to a comfortable listening level.
 - The LED indicator turns green, when the received signal contains the same CTCSS tone or DTCS code.
 - When no transmission is heard, push and hold **[MONI]** while adjusting **[VOL]**.
- ④ The transceiver is now set to receive desired calls on the selected channel.

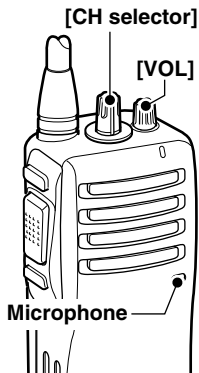

Transmitting:

Wait for the channel to become clear to avoid interference.

- ① While pushing and holding **[PTT]**, speak into the microphone at a normal voice level.
 - The LED indicator turns red.
- ② Release **[PTT]** to return to receive.

/// **IMPORTANT!:** To maximize the readability of your signal;

1. Pause briefly after pushing **[PTT]**.
2. Hold the microphone 5 to 10 cm from your lips, then speak into the microphone at a normal voice level.

◇ Frequency channel/CTCSS tone list (default)

CH	Frequency (MHz)*1	Tone (Hz)*2
1	446.006250	No setting
2	446.018750	No setting
3	446.031250	No setting
4	446.043750	107.2
5	446.056250	110.9
6	446.068750	114.8
7	446.081250	118.8
8	446.093750	123.0
9	446.006250	127.3
10	446.018750	131.8
11	446.031250	136.5
12	446.043750	141.3
13	446.056250	146.2
14	446.068750	151.4
15	446.081250	156.7
16	Auto Scan	—

*1 All operating channel frequencies cannot be changed.

*2 CTCSS tones can be programmed. You can use DTCS (Digital Tone Code Squelch) instead of CTCSS. (p. 15)

■ Setting the squelch level

The squelch circuit mutes the received audio signal depending on the signal strength.

- ① Turn power OFF in advance.
- ② While pushing and holding **[PTT]** and **[Lower]**, rotate **[VOL]** to turn power ON to enter the squelch adjustment mode.
 - A beep (Pi) is emitted.
- ③ Push **[Upper]** to increase the squelch level (tight squelch) or **[Lower]** to decrease the squelch level (loose squelch).
 - Squelch level will be fixed after 1 sec.
- ④ Turn power OFF, then ON again.

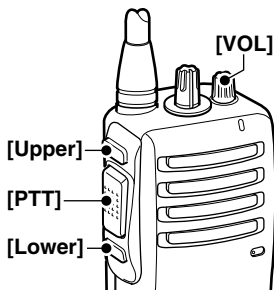

■ Auto scan function

Auto scan function proceeds from lower channel to higher channel numbers in sequence. Scanning searches for signals automatically and makes it easier to locate new stations for contact or listening purposes.

- ① Rotate **[CH selector]** to select channel 16.
- ② Scan starts automatically.
 - The LED indicator blinks green slowly.
 - When receiving a signal, scan pauses until the signal disappears.

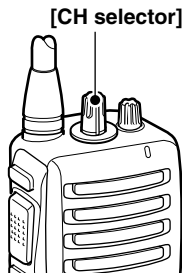

■ Battery type selection

The battery type **MUST** be selected according to the type of battery attached when turning the transceiver ON.

Ask your dealer for details.

NOTE: When the selected battery type is not matched to the attached battery, the transceiver does not work correctly.

- ① Turn power OFF in advance.
- ② While pushing and holding **[PTT]**, rotate **[VOL]** to turn power ON.
- ③ After the transceiver is powered ON, you should hold **[PTT]** for 5 sec. to toggle the attached battery type.
 - When the Lithium-Ion battery type is selected, a beep (Pi) is emitted after a 5 sec. count.
 - When the Alkaline battery type is selected, 2 beeps (PiPi) are emitted after a 5 sec. count.

In this case, the LED indicator turns orange while transmitting a signal.

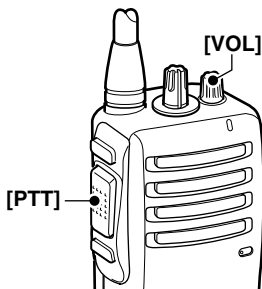

■ Setting the group code number

◇ CTCSS tone setting

The transceiver is equipped with 50 CTCSS tones and OFF. CTCSS operation provides communication with silent standby since you will only receive calls from group members using the same CTCSS tone.

- ① Turn power OFF in advance.
- ② While pushing and holding **[PTT]**, **[Upper]** and **[Lower]**, rotate **[VOL]** to turn the power ON.
- ③ Rotate **[CH selector]** to select the desired channel (1 to 15) that you want to assign the CTCSS tone to.
- ④ Push and hold **[Upper]** until a long beep is emitted.
- ⑤ Push **[PTT]** the necessary number of times to choose the 10 digit of the desired CTCSS tone number (grey column) from the list at right.
- ⑥ Push **[Upper]**.
 - Confirmation beep(s) is (are) emitted. (See the Confirmation beep list at right.)
- ⑦ Push **[PTT]** the necessary number of times to choose the 1 digit of the desired CTCSS tone number (grey column) from the list at right.
- ⑧ Push **[Upper]** to complete the setting.
 - Confirmation beep(s) is (are) emitted. (See the Confirmation beep list at right.)
- ⑨ Turn power OFF, then ON again.

[Example]: Tone No. 28 (162.2 Hz) assignment to channel 4

- ① Turn power OFF in advance.
- ② While pushing and holding **[PTT]**, **[Upper]** and **[Lower]**, rotate **[VOL]** to turn the power ON.
- ③ Rotate **[CH selector]** to select channel 4, then push and hold **[Upper]** until a long beep is emitted.

- ④ Push **[PTT]** twice to choose the 2 (10 digit) of the tone number 28.
- ⑤ Push **[Upper]** (2 short beeps are emitted,) then push **[PTT]** eight times to choose the 8 (1 digit) of the tone number 28.
- ⑥ Push **[Upper]** to complete the setting.
 - A long beep and 3 short beeps are emitted.
- ⑦ Turn power OFF, then ON again.

• Available CTCSS tone list (Hz)

No.	Freq.	No.	Freq.	No.	Freq.	No.	Freq.	No.	Freq.
01	67.0	11	94.8	21	131.8	31	171.3	41	203.5
02	69.3	12	97.4	22	136.5	32	173.8	42	206.5
03	71.9	13	100.0	23	141.3	33	177.3	43	210.7
04	74.4	14	103.5	24	146.2	34	179.9	44	218.1
05	77.0	15	107.2	25	151.4	35	183.5	45	225.7
06	79.7	16	110.9	26	156.7	36	186.2	46	229.1
07	82.5	17	114.8	27	159.8	37	189.9	47	233.6
08	85.4	18	118.8	28	162.2	38	192.8	48	241.8
09	88.5	19	123.0	29	165.5	39	196.6	49	250.3
10	91.5	20	127.3	30	167.9	40	199.5	50	254.1
								00	OFF

• Confirmation beep list

Push [PTT]	Confirmation beep	Push [PTT]	Confirmation beep
No push	●	5 (Fifth)	●●●●●
1 (Once)	●	6 (Sixth)	■●
2 (Twice)	●●	7 (Seventh)	■●●
3 (Third)	●●●	8 (Eighth)	■●●●
4 (Fourth)	●●●●	9 (Ninth)	■●●●●

● : Short beep ■ : Long beep

3 BASIC OPERATION

◆ DTCS code setting

This transceiver is equipped with 84 DTCS codes and OFF. DTCS operation provides communication with silent standby since you will only receive calls from group members using the same DTCS code.

- ① Turn power OFF in advance.
- ② While pushing and holding **[PTT]**, **[Upper]** and **[Lower]**, rotate **[VOL]** to turn the power ON.
- ③ Rotate **[CH selector]** to select the desired channel (1 to 15) that you want to assign the DTCS code to.
- ④ Push and hold **[Lower]** until a long beep is emitted.
- ⑤ Push **[PTT]** the necessary number of times to choose the 10 digit of the desired DTCS code number (grey column) from the list at right.
- ⑥ Push **[Upper]**.
 - Confirmation beep(s) is (are) emitted. (See the Confirmation beep list on p. 14.)
- ⑦ Push **[PTT]** the necessary number of times to choose the 1 digit of the desired DTCS code number (grey column) from the list at right.
- ⑧ Push **[Upper]**.
 - Confirmation beep(s) is (are) emitted. (See the Confirmation beep list on p. 14.)
- ⑨ If you want to use **Inverse** mode, push **[PTT]** once more.
*You can skip this step, if you want to use **Normal** mode.
- ⑩ Push **[Upper]** to complete the setting.
 - A short beep is emitted.
- ⑪ Turn power OFF, then ON again.

[Example]: Code No. 16 (114) with Inverse mode assignment to channel 5

- ① Turn power OFF in advance.
- ② While pushing and holding **[PTT]**, **[Upper]** and **[Lower]**, rotate **[VOL]** to turn the power ON.

- ③ Rotate [**CH selector**] to select channel 5, then push and hold [**Lower**] until a long beep is emitted.
- ④ Push [**PTT**] once to choose the 1 (10 digit) of the code number 16.
- ⑤ Push [**Upper**] (a short beep is emitted,) then push [**PTT**] six times to choose the 6 (1 digit) of the code number 16.
- ⑥ Push [**Upper**].
 - A long beep and a short beep are emitted.
- ⑦ Push [**PTT**] once more, to use **Inverse** mode.
- ⑧ Push [**Upper**] to complete the setting.
 - A short beep is emitted.
- ⑨ Turn the power OFF, and then ON again.

• Available DTCS code list

No.	Code	No.	Code	No.	Code	No.	Code	No.	Code
01	023	11	065	21	132	31	205	41	271
02	025	12	071	22	134	32	223	42	306
03	026	13	072	23	143	33	226	43	311
04	031	14	073	24	152	34	243	44	315
05	032	15	074	25	155	35	244	45	331
06	036	16	114	26	156	36	245	46	343
07	043	17	115	27	162	37	251	47	346
08	047	18	116	28	165	38	261	48	351
09	051	19	125	29	172	39	263	49	364
10	054	20	131	30	174	40	265	50	365
51	371	61	466	71	627	81	732		
52	411	62	503	72	631	82	734		
53	412	63	506	73	632	83	743		
54	413	64	516	74	654	84	754		
55	423	65	532	75	662	00	OFF		
56	431	66	546	76	664				
57	432	67	565	77	703				
58	445	68	606	78	712				
59	464	69	612	79	723				
60	465	70	624	80	731				

■ Find scan operation

This transceiver can detect the CTCSS tone and DTCS code* in the received signal. By monitoring a signal that is being transmitted from the other station, you can determine the tone frequency or DTCS code* required to communicate with them.

This function is very useful when you are going to communicate with unknown CTCSS tone or DTCS code* stations.

Scans all of the CTCSS tone and DTCS code*, then stops when a matched tone or code* is detected.

- ① Turn power OFF in advance.
- ② While pushing and holding **[Upper]** and **[Lower]**, rotate **[VOL]** to turn power ON.
 // **Do not select channel 16** before turning power ON.
- ③ Rotate **[CH selector]** to select the desired channel (1 to 15) that you want to assign the CTCSS tone or DTCS code* to.
- ④ Push and hold **[Upper]** for 1 sec. to start scan.
 - The LED indicator blinks green slowly.
 - Push **[Upper]** to stop the scan.
- ⑤ The scan pauses when the matched tone or code* is detected.
 - Push **[Upper]** to determine the detected tone or code* number, and stop the scan.
 - Scan resumes 3 sec. after the signal disappears.
- ⑥ Turn power OFF, then ON again.

// Even if the scan is stopped with pushing **[Upper]**, scan resumes after pushing and holding **[Upper]**.

* Depends on the pre-setting.

■ Call-Ring operation

Sends the pre-selected ring tone to your group members.

◇ Select the Call-Ring melody

- ① Turn power OFF in advance.
- ② While pushing and holding **[PTT]** and **[Upper]**, rotate **[VOL]** to turn power ON.
 - A sample melody is emitted.
- ③ Rotate **[CH selector]** to select the ringer melody.
- ④ Turn power OFF to determine the melody.

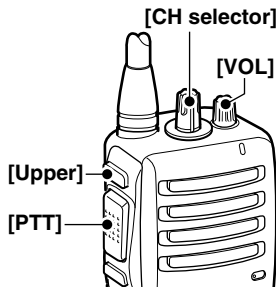

◇ Call your group member with Call-Ring melody

- ① Set the same operating channel and CTCSS tone for all of your group transceivers. (p. 13)
- ② Pushing and holding **[Smart Ring/Ringer]** for 1 sec. to send the pre-selected ring tone to your group member.
 - The ring tone is emitted while **[Smart Ring/Ringer]** is pushed and held.
 - The same ring tone comes from your group station's speaker.

■ Smart-Ring operation

The ring function has an answer back feature. This allows you to confirm whether or not a call has reached to the member of your group even if the operator is temporarily away from the transceiver.

◇ Smart-Ring operation

- ① Set the same operating channel and CTCSS tone code for all of your group transceivers. (p. 13)
- ② Push **[Smart Ring/Ringer]** to send the Smart-Ring call.
 - When a member of your group station answers your call, the transceiver emits beep tones for every 10 sec.* and the LED indicator blinks with an orange color.
*Depends on the pre-setting.
 - Push **[MONI]** to cancel the Ringer beep and the LED blinking.
 - When no answer comes back, the transceiver emits short failure beep tones.
- ③ Push **[PTT]** to answer the call and to stop the beeps and blinking.

 **NOTE:** This function is available only when the called station has use the same CTCSS tone code and the same operating channels as you.

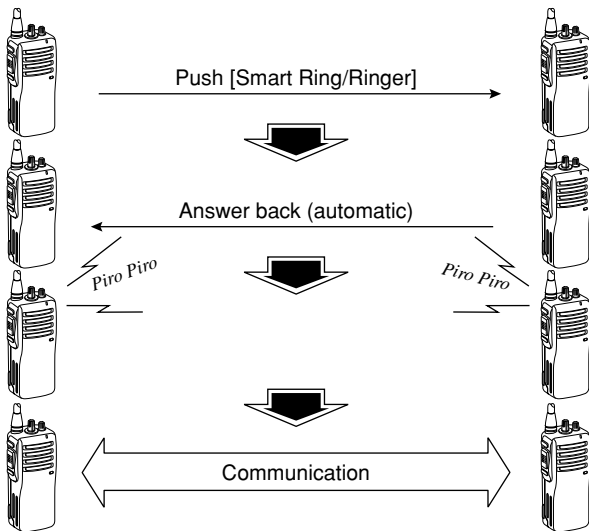

5 OTHER FUNCTIONS

■ Monitor audible function

The monitor function allows you to open the transceiver's squelch manually to check whether a channel is busy or not. The transceiver has 2 conditions for receive standby.

• Audible condition

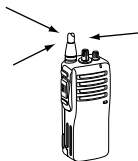

All signals are received

This condition mutes audio **ONLY** when no carrier is present. You can receive (or monitor) any signals on a channel.

- Push and hold **[MONI]** to release the CTCSS or DTCS tone squelch mute.

Any received audio is emitted while pushing and holding **[MONI]**.

• Inaudible condition

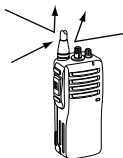

Only signals containing the proper tone are received.

This condition mutes **ALL** signals except those directed to you. Therefore you should check a channel's condition (busy or not) with the monitor function before transmitting.

- Push **[MONI]** to mute the CTCSS or DTCS tone squelch mute.

■ Time-Out Timer

The transceiver has a time-out timer function. This function prevents continuous, extend transmissions. This timer automatically turns a transmission OFF 3 min. after it starts.

■ Power save function

The power save function reduces the current drain to conserve battery power.

- The power save function is automatically turned ON when no operation is performed or no signal is received for 5 sec.

■ Low battery indication

The LED indicator indicates 4 levels of the “Low battery” condition as follows.

If the “Low battery” warning occurs during operation, please charge or replace the battery.

[Blink patterns]

- Low BATT1: You should charge the battery. (blinks slowly)



- Low BATT2: You must charge the battery. (blinks fast)

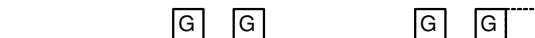

- TX low BATT1: Low BATT1 was detected during TX mode.



- TX low BATT2: Low BATT2 was detected during TX mode.



In an extreme low temperature surroundings (around -20°C), the capacity of the battery may exhaust quickly (especially Alkaline batteries). In such a case, we recommend to charge the battery or replace the batteries, when the “Low Battery” indication occurs during operation.

■ Scrambler function

The voice scrambler function provides private communication between stations. The optional UT-110 (Rolling) or UT-109 (Non-rolling) is required. Ask your dealer for details.

- ① Push and hold [**Scrambler**] for 1 sec, to turn the scrambler function ON.
 - A short beep and a long beep are emitted.
- ② Push [**Scrambler**] to turn the scrambler function OFF.
 - A short beep is emitted.

■ All reset function

Reset the CPU before operating the transceiver for the first time, or if the internal CPU malfunctions, to clear and return all programmed contents to their default settings.

- ① Turn power OFF in advance.
- ② Rotate [**CH selector**] to select channel 16.
- ③ While pushing and holding [**PTT**], [**Upper**] and [**Lower**], rotate [**VOL**] to turn power ON.
- ④ After the transceiver is powered ON, you should hold [**PTT**], [**Upper**] and [**Lower**] for 5 sec. to reset the CPU.
 - A long beep is emitted.
- ⑤ Turn power OFF.

 **CAUTION:** Resetting the CPU returns all programmed contents to their default settings.

■ Caution

Misuse of Lithium-Ion batteries may result in the following hazards: smoke, fire, or the battery may rupture. Misuse can also cause damage to the battery or degradation of battery performance.

⚠ **DANGER!** Use and charge only specified Icom battery packs with Icom radios or Icom charger. Only Icom battery packs are tested and approved for use and charge with Icom radios or Icom charger. Using third-party or counterfeit battery packs or charger may cause smoke, fire, or cause the battery to burst.

◆ Battery caution

⚠ **DANGER! DO NOT** hammer or otherwise impact the battery. Do not use the battery if it has been severely impacted or dropped, or if the battery has been subjected to heavy pressure. Battery damage may not be visible on the outside of the case. Even if the surface of the battery does not show cracks or any other damage, the cells inside the battery may rupture or catch fire.

⚠ **DANGER! NEVER** use or leave battery packs in areas with temperatures above +60°C. High temperature buildup in the battery, such as could occur near fires or stoves, inside a sun heated car, or in direct sunlight may cause the battery to rupture or catch fire. Excessive temperatures may also degrade battery performance or shorten battery life.

⚠ **DANGER! DO NOT** expose the battery to rain, snow, seawater, or any other liquids. Do not charge or use a wet battery. If the battery gets wet, be sure to wipe it dry before using. The battery is not waterproof.

⚠ **DANGER! NEVER** incinerate used battery packs since internal battery gas may cause them to rupture, or may cause an explosion.

6 BATTERY CHARGING

⚠ **DANGER! NEVER** solder the battery terminals or **NEVER** modify the battery pack. This may cause heat generation, and the battery may rupture, emit smoke or catch fire.

⚠ **DANGER!** Use the battery only with the transceiver for which it is specified. Never use a battery with any other equipment, or for any purpose that is not specified in this instruction manual.

⚠ **DANGER!** If fluid from inside the battery gets in your eyes, blindness can result. Rinse your eyes with clean water, without rubbing them, and see a doctor immediately.

WARNING! Immediately stop using the battery if it emits an abnormal odor, heats up, or is discolored or deformed. If any of these conditions occur, contact your Icom dealer or distributor.

WARNING! Immediately wash, using clean water, any part of the body that comes into contact with fluid from inside the battery.

WARNING! NEVER put the battery in a microwave oven, high-pressure container, or in an induction heating cooker. This could cause a fire, overheating, or cause the battery to rupture.

CAUTION! Always use the battery within the specified temperature range for the transceiver (-25°C to $+55^{\circ}\text{C}$) and the battery itself (-20°C to $+60^{\circ}\text{C}$). Using the battery out of its specified temperature range will reduce the battery's performance and battery life. Please note that the specified temperature range of the battery may exceed that of the transceiver. In such cases, the transceiver may not work properly because it is out of its operating temperature range.

CAUTION! Shorter battery life could occur if the battery is left fully charged, completely discharged, or in an excessive temperature environment (above $+45^{\circ}\text{C}$) for an extended period of time. If the battery must be left unused for a long time, it must be detached from the radio after discharging. You may use the battery until the remaining capacity is about half, then keep it safely in a cool dry place with the temperature between -20°C to $+25^{\circ}\text{C}$.

◇ Charging caution

⚠ **DANGER! NEVER** charge the battery pack in areas with extremely high temperatures, such as near fires or stoves, inside a sun heated car, or in direct sunlight. In such environments, the safety/protection circuit in the battery will activate, causing the battery to stop charging.

WARNING! DO NOT charge or leave the battery in the battery charger beyond the specified time for charging. If the battery is not completely charged by the specified time, stop charging and remove the battery from the battery charger. Continuing to charge the battery beyond the specified time limit may cause a fire, overheating, or the battery may rupture.

WARNING! NEVER insert the transceiver (battery attached to the transceiver) into the charger if it is wet or soiled. This could corrode the battery charger terminals or damage the charger. The charger is not waterproof.

CAUTION! DO NOT charge the battery outside of the specified temperature range: BC-160 and BC-171 (0°C to +45°C). Icom recommends charging the battery at +20°C. The battery may heat up or rupture if charged out of the specified temperature range. Additionally, battery performance or battery life may be reduced.

■ Battery chargers

◇ Rapid charging with the BC-160

The BC-160 provides rapid charging of the optional Li-Ion battery pack. Charging period: Approx. 3 hours (with BP-232N)

The following items are additionally required:

- An AC adapter (may be supplied depending on version) or the DC power cable (OPC-515L/CP-17L) is additionally required.

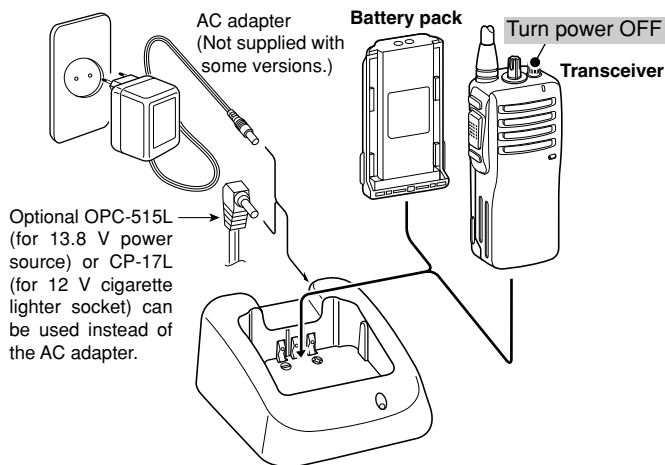

◇ Regular charging with the BC-171

The BC-171 provides regular charging of the optional Li-Ion battery pack. Charging period: Approx. 10 hours (with BP-232N)

The following items are additionally required:

- An AC adapter (may be supplied depending on version) or the DC power cable (OPC-515L/CP-17L) is additionally required.

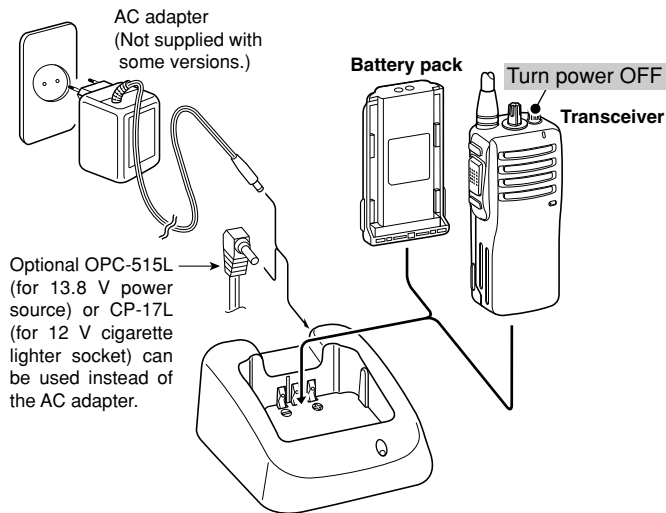

6 BATTERY CHARGING

◆ AD-106 installation

- ① Install the AD-106 desktop charger adapter into the holder space of the BC-119N/BC-121N.

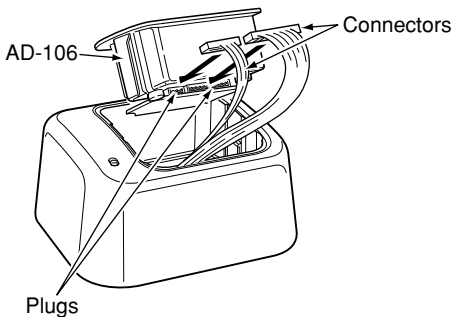

- ② Connect the plugs of the BC-119N/BC-121N to the AD-106 with the connector, then install the adapter into the charger with the supplied screws.

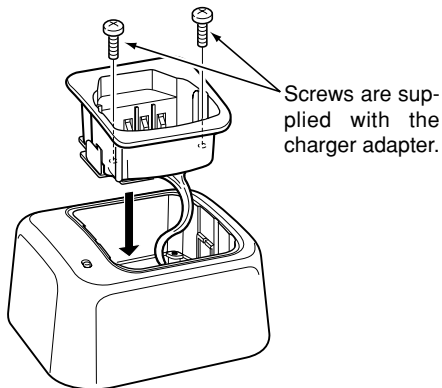

◇ Rapid charging with the BC-119N+AD-106

The optional BC-119N provides rapid charging of the Li-Ion battery packs. Charging period: Approx. 3 hours (with BP-232N)

The following items are additionally required:

- An AD-106 charger adapter
- An AC adapter (may be supplied with the BC-119N depending on version) or the DC power cable (OPC-515L/CP-17L).

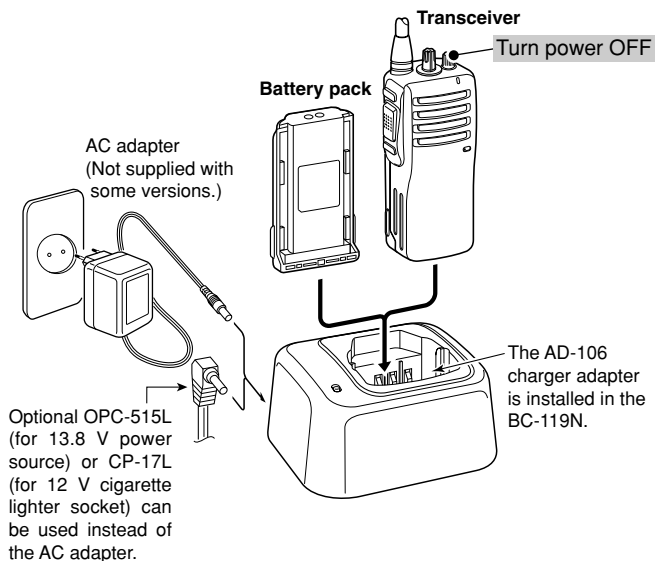

6 BATTERY CHARGING

◇ Rapid charging with the BC-121N+AD-106

The optional BC-121N allows up to 6 battery packs to be charged simultaneously. Charging period: Approx. 3 hours (with BP-232N)

The following items are additionally required.

- Six AD-106 charger adapters
- An AC adapter (BC-157) or the DC power cable (OPC-656)

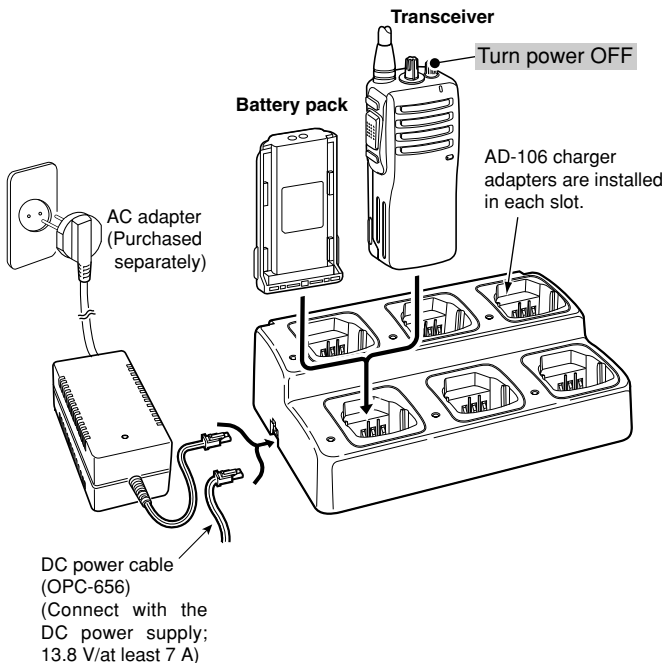

IMPORTANT!: Battery charging caution

Ensure the guide lobes on the battery pack are correctly aligned with the guide rails inside the charger adapter. (This illustration is shown using the BC-160.)

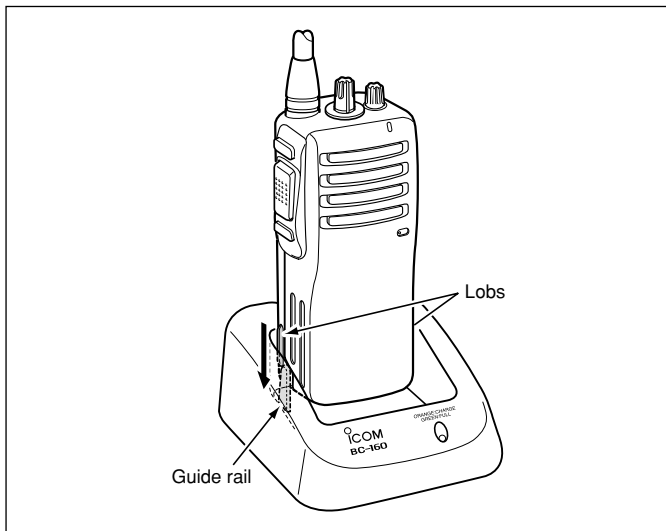

7 BATTERY CASE

■ Optional battery case (BP-240)

When using the optional battery case, install 6 × AAA (LR03) size alkaline batteries as illustrated at right.

- ① Unhook the battery cover release hook (❶), and open the cover in the direction of the arrow (❷). (Fig.1)
- ② Then, install 6 × AAA (LR03) size alkaline batteries. (Fig.2)
 - Install the alkaline batteries only.
 - Be sure to observe the correct polarity.
 - Do not pin the ribbon under the batteries.
- ③ Fit the cover in the direction of the arrow (❸), then close (❹). Hook the battery cover release hook until it makes a 'click' sound (❺). (Fig.3)

CAUTION:

- When installing batteries, make sure they are all the same brand, type and capacity. Also, do not mix new and old batteries together.
- Keep battery contacts clean. It's a good idea to clean battery terminals once a week.
- Never incinerate used battery cells since internal battery gas may cause them to rupture.
- Never expose a detached battery case to water. If the battery case gets wet, be sure to wipe it dry before using it.

NOTE: When the optional battery case is attached, the battery type must be selected to "Alkaline battery operation" when turning the transceiver ON. (p. 12)

Fig.1

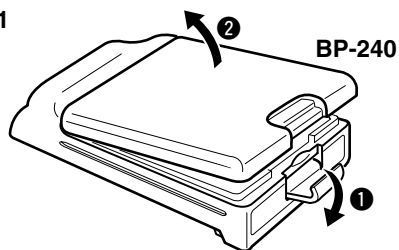

Fig.2

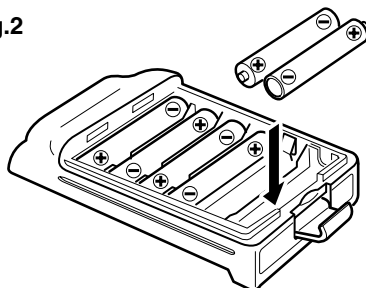
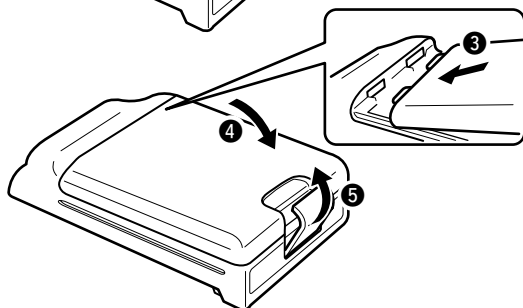

Fig.3



8 SWIVEL BELT CLIP

■ MB-93 contents

	Qty.
① Belt clip	1
② Base clip	1

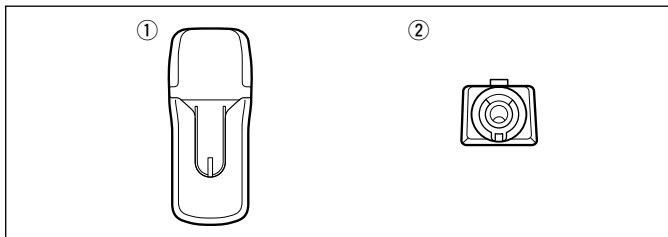

■ Attaching

- ① Release the battery pack if it is attached. (p. 2)
- ② Slide the base clip in the direction of the arrow until the base clip is locked and makes a 'click' sound.

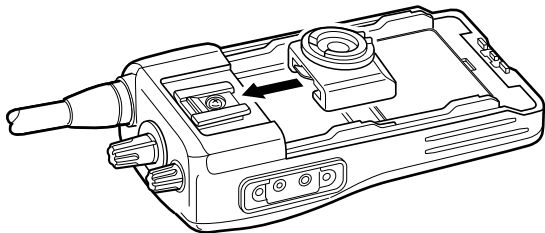

- ③ Clip the belt clip to a part of your belt. And insert the transceiver into the belt clip until the base clip is inserted fully into the groove.

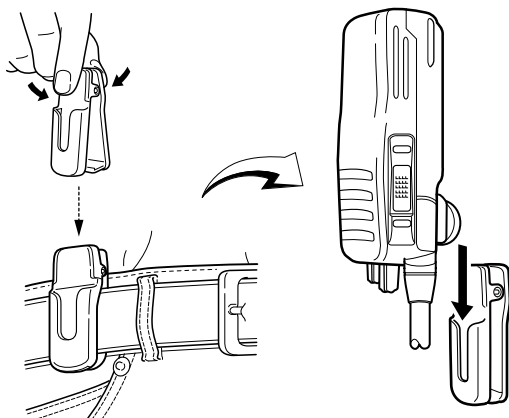

- ④ Once the transceiver is locked in place, it swivels as illustrated below.

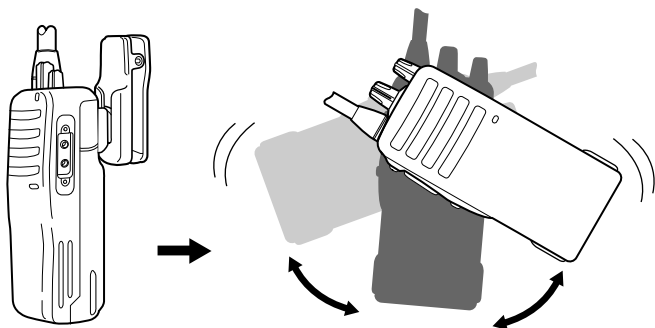

Once the transceiver is locked in place, it will swivel 360 degrees.

■ Detaching

- ① Turn the transceiver upside down in the direction of the arrow and pull out from the belt clip.

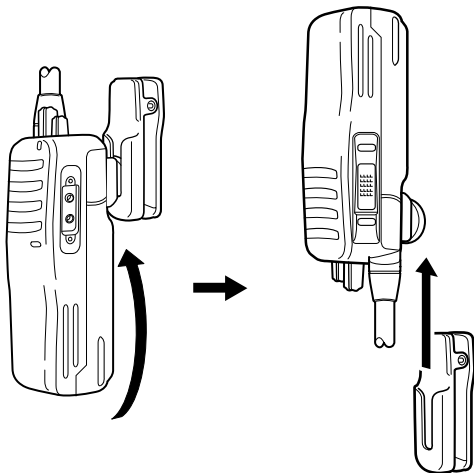

- ② Release the battery pack if it is attached. (p. 2)
- ③ Pinch to lift the clip (①), and slide the base clip in the direction of the arrow (②).

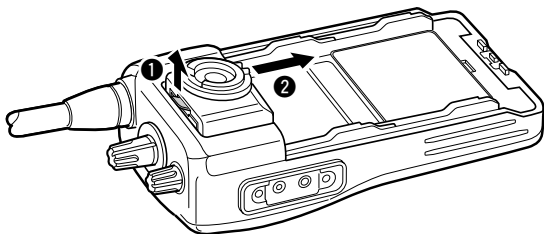

8

CAUTION:
HOLD THE TRANSCEIVER TIGHTLY, WHEN HANGING OR DETACHING THE TRANSCEIVER FROM THE BELT CLIP.
Otherwise the transceiver may not be attached to the holder or swivel properly if the transceiver is accidentally dropped and the base clip is scratched or damaged.

9 OPTIONS

◇ BATTERY PACKS

Battery pack	Voltage	Capacity	Battery life* ¹
BP-230N	7.4 V	980 mAh	13 hrs.
BP-232N	7.4 V	2000 mAh	26.5 hrs.
BP-240	Battery case for AAA (LR03) × 6 alkaline		—* ²

*¹ When the power save function is turned ON, and the operating periods are calculated under the following conditions;

TX : RX : Standby = 5 : 5 : 90

*² Operating period depends on the alkaline cells used.

◇ CHARGERS

- **BC-119N** DESKTOP CHARGER + **AD-106** CHARGER ADAPTER
+ **BC-145** AC ADAPTER

For rapid charging of battery pack. An AC adapter is supplied with the charger depending on versions.

Charging time: Approx. 3 hours when BP-232N is attached.

- **BC-121N** MULTI-CHARGER + **AD-106** CHARGER ADAPTER (6 pcs.)
+ **BC-157** AC ADAPTER

For rapid charging of up to 6 battery packs (six AD-106's are required) simultaneously. An AC adapter should be purchased separately.

Charging time: Approx. 3 hours when BP-232N is attached.

- **BC-160** DESKTOP CHARGER + **BC-145** AC ADAPTER

For rapid charging of battery packs. An AC adapter is supplied with the charger depending on versions.

Charging time: Approx. 3 hours when BP-232N is attached.

- **BC-171** DESKTOP CHARGER + **BC-147** AC ADAPTER

For regular charging of battery packs. We recommend that the BP-230N charging. An AC adapter is supplied with the charger depending on versions.

Charging time: Approx. 10 hours when BP-232N is attached.

Approx. 4 hours when BP-230N is attached.

◇ OPTIONAL UNITS

- **UT-109 (#01)/UT-110 (#01)** SCRAMBLER UNITS
Non-rolling type (UT-109)/Rolling type (UT-110) voice scrambler unit provides higher communication security.

◇ BELT CLIPS

- **MB-93** SWIVEL BELT CLIP
- **MB-94** BELT CLIP
Exclusive alligator-type belt clip.
- **MB-96N/96F** LEATHER BELT HANGER

◇ DC CABLES

- **CP-17L** CIGARETTE LIGHTER CABLE
Allows charging of the battery pack through a 12 V cigarette lighter socket. (For BC-119N)
- **OPC-515L/OPC-656** DC POWER CABLES
Allows charging of the battery pack using a 13.8 V power source instead of the AC adapter.
OPC-515L : For BC-119N
OPC-656 : For BC-121N

◇ OTHER OPTIONS

- **SP-13** EARPHONE
Provides clear receive audio in noisy environments.
- **HM-153L** EARPHONE-MICROPHONE
- **HM-158L/159L** SPEAKER-MICROPHONE
Combination speaker-microphone that provides convenient operation while hanging the transceiver from your belt.
- **HS-94/HS-95/HS-97** HEADSET + **VS-1L** VOX/PTT CASE
HS-94 : Ear hook type HS-95: Neck-arm type
HS-97 : Throat microphone
VS-1L : VOX/PTT switch box for hands-free operation, etc.

Some options may not be available in some countries. Please ask your dealer for details.

10 SPECIFICATIONS

◆ General

- Frequency coverage : 446.00625–446.09375 MHz
- Mode : 8K50F3E (FM)
- Current drain (at 7.2 V) : TX (at 0.5 W ERP) 0.4 A approx.
Max. audio 300 mA max.
- Power supply requirement : 7.2 V DC nominal*
(negative ground)
*Specified Icom's battery pack only
- Frequency stability : ± 2.5 ppm
(-25°C to $+55^{\circ}\text{C}$)
- Antenna impedance : 50 Ω nominal
- Dimensions : 53.0(W) \times 195.0(H) \times 38.0(D) mm
(Fixed type antenna included)
- Weight : Approx. 300 g (including BP-232N)

◆ Transmitter

- Output power : 0.5 W ERP
- Modulation system : Variable reactance frequency modulation
- Max. frequency deviation : ± 2.5 kHz
- Spurious emissions : 0.25 μW below 1 GHz
1.00 μW above 1 GHz
- Adjacent channel power : 60 dB
- External mic. connector : 3-conductor 2.5 (d) mm/2.2 k Ω

◆ Receiver

- Receive system : Double conversion superheterodyne
- Sensitivity (20 dB SINAD) : 26.5 dB μ V/m
- Squelch sensitivity : 26.5 dB μ V/m (Threshold)
- Intermodulation rejection ratio : 86.29 dB μ V/m
- Spurious response rejection ratio : 91.29 dB μ V/m
- Adjacent channel selectivity : 81.29 dB μ V/m
- Audio output power : 0.5 W (typical) at 5% distortion with an 8 Ω load
0.6 W (typical) at 5% distortion with a 6 Ω load
- External speaker connector : 2-conductor 3.5 (d) mm/8 Ω

All stated specifications are subject to change without notice or obligation.

Count on us!

< Intended Country of Use >

GER FRA ESP SWE
 AUT NED POR DEN
 GBR BEL ITA FIN
 IRL LUX GRE SUI
 NOR